



PCB CREATION

Manufacture d'émotions

ABBREVIATIONS

Dark choc: Dark chocolate

White choc: White chocolate

Milk choc: Milk chocolate

Choc BC: White caramelised chocolate

Compound: Dark or white compound coating

BLISTERS: Thermoformed imprints to fill with chocolate

SAVOIR-FAIRE & METHOD OF USE

Discover Savoir Faire by PCB Création,
A collection of methods that you can read as a compilation
of step by step advices and tips.



Scan the QR Code and have access to technical sheets for
each category of product, to chefs' tips and tutorial videos.
Explore your online dedicated space!

PICTOGRAMS

NEW 000000

This is new

 Free of colouring

The references without dye (formerly «Pure Emotion») are indicated by this pictogram.

 Possible migration on white chocolate
References that present a risk of migration on White choc are indicated by this pictogram.

 Sensitivity to humidity
References that are sensitive to moisture (i.e. colours that are likely to bleed onto substrates or be less intense) are indicated by this pictogram.

● Azo
Azo references are indicated by a chip after the designation.

●●● Usable chocolates
Our chocolate recommendations for an optimal rendering.



DO YOU HAVE A TECHNICAL QUESTION?
A CREATIVE PROBLEM CONCERNING
OUR PRODUCTS ? DO YOU NEED SOME ADVICE
OR A PROFESSIONAL'S OPINION?

We provide all the experience of our pastry chef and his in-depth
knowledge of our products and relevant techniques.
You can send your request to our Customer Service
who will take pleasure in calling upon him.

Export Customer Service
+33 (0)3 88 587 336

From us
to you

Dear creative optimists,

If you're reading this, you probably share our vision of creativity.

Creativity that, to exist fully, must always be in motion.

Creativity that is a dance guided by agility, adaptation and dynamism. It thumbs its nose at automatically closed doors, at ideas that are cancelled before they even exist, at the *'it's not possible'*, the *'we can't do it'*, the *'it's ruined'*, the *'yes but'*.

Creativity that always seeks and finds a solution, that knows that sometimes inspiration and innovation come from the unexpected.

Creativity that rhymes with the culture of challenge, that willingly ventures outside its comfort zone because it knows that this is how we invent, reinvent and reinvent ourselves.

Built on expertise, precision and technique, not forgetting daring and a touch of madness required for each idea, it's this creativity that allows *'create'* and *'dream'* to be conjugated in the present and future tenses.

Creativity also knows that when you conjugate a verb in the plural, you will always go further. It offers the freedom to believe in your ideas, to bring them to life in their best possible form. We support all your ideas (*even if sometimes a little crazy*).

We support those who believe in the possible.

We support those who do their utmost to make it possible.

We support the freedom to imagine.

With daring and optimism,

PCB Création

CUSTOMIZE YOUR MACAROONS!

Make your macaroons unique, thanks to this original concept developed by Thierry Atlan, Meilleur Ouvrier de France Chocolatier (Best Chocolatier in France) based in New York.

It's very simple:

We personalise the blister packs with your logo or the message of your choice.
Then all you have to do is pour your chocolate into the blister and place your macaroon shell on top...
(For easier use, the blisters are designed to be suitable for one-shot filling)

Your macaroons will then be covered in a delicate layer of personalised chocolate.



Contact-us
to customize your
blister for macaroons.



FOR A REAL EYE CATCHER:
CUSTOMIZE THEM WITH YOUR LOGO,
YOUR FAVOURITE PATTERNS,
OR WHY NOT TRY PRINTING SOME
SWEET THINGS.

1

What's new ??

- “Biscuités“ decorations p. 17
- Silicone moulds p. 233
- Silicone mats p. 239
- King's cake stencils p. 241

Festive themes

- Halloween p. 25
- Thanksgiving p. 32
- Advent p. 34
- Christmas p. 39
- New year p. 67
- Love p. 111
- Mother & father's day p. 114
- Asian collection p. 119
- Easter p. 121
- Middle east collection p. 145

2

3

Timeless

- Meringués p. 19
- Opalines p. 23
- Eyes & accessories p. 147
- Nature p. 149
- Classic decorations p. 159
- Birthday p. 173
- Marshmallow decorations p. 175
- Decorations to sprinkle p. 183
- Transfer sheets p. 193
- Structure sheets for bonbon p. 203
- Kits p. 81

Table of contents

To fill & Entremets

- Shells and half-shells to fill p. 221
- Pompons and pomponettes p. 225
- Tart shells Made in France p. 229
- Silicone moulds p. 233
- Silicone mats p. 239
- Tearable entremets moulds p. 249
- Entremets moulds p. 255
- Structure sheets for entremets p. 258
- Transfer sheets for entremets p. 260

4

Ingredients

- Ingredient p. 263

5

Colouring

- Understanding colour p. 271
- Powders 100% fruit/vegetal p. 273
- Coloring powder p. 275
- Cocoa butters p. 281
- Velvet sprays p. 287
- Varnish p. 289
- Decor à modeler p. 291
- Tubes to fill and pipettes p. 292

6

Summary p. 296

7

CUSTOM MADE BY PCB CRÉATION

**N°1
IN FRANCE**

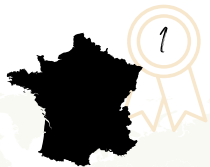

WHAT AM I SAYING?
IN THE WHOLE WORLD!

1138

**TYPES & SHAPES FOR
CUSTOMIZABLE PRODUCTS**



DON'T PANIC, WE WON'T SHOW
YOU EVERYTHING HERE...
(SERIOUSLY, HAVE YOU SEEN THE
SIZE OF OUR CATALOGUE?)

DISCOVER JAMBELI

**DISCOVER OUR ORIGIN
CHOCOLATE COUVERTURE
FROM AN ECUADORIAN
FARM ESTATE SELECTED
FOR YOU : JAMBELI!**

WHAT ELSE?



more than
30 years

OF EXPERTISE

AGE IS ALL IN THE MIND



**WE PRODUCE
ENTIRELY IN OUR FACTORY
IN ALSACE**

ELSASSISCH ISCH BOMBISCH. ALTHOUGH
WE WOULDN'T MIND SETTLING DOWN
IN THE MALDIVES. BUT WE'RE TOLD
THAT IT'S NOT THE BEST FOR
CHOCOLATE.

THEY TRUST US

*Pierre Hermé,
Christophe Adam,
Vincent Guerlais,
Christophe Michalak,
Maison Ladurée,
Cédric Grolet,
Maison Lenôte,
Lilan Bonnefoi,
Marc Ducobu,
Quentin Bailly,
Alain Chartier,
Maison Feuillette...*

SEPTEMBER 10TH 1995

**THE FIRST MADE-TO-
MEASURE PRODUCT
LEAVES OUR FACTORY**

YOU NEVER FORGET
YOUR FIRST TIME

more than

200 000

CUSTOMERS WORLDWIDE

BY THE WAY, WE ARE OPEN TO THE IDEA
OF A WORLD TOUR TO MEET YOU ALL!
SEND YOUR INVITATIONS TO
STUDIO@PCB-CREATION.FR

WHY CUSTOMIZE?



**STAND OUT FROM
YOUR COMPETITORS**
SIMPLY THE BEST



**SIGN YOUR PRODUCTS
& BE RECOGNIZED**
HELLO, IS IT ME YOU'RE
LOOKING FOR?



**CREATE YOUR COLLECTIONS
& CREATE EMOTION**
TAKE A WALK ON THE
WILD SIDE

RITZ CARLTON X PCB CRÉATION

DENIS TOUCHERON



1
INSPIRATION:
POLAR BEAR



2
MOULD
CREATION

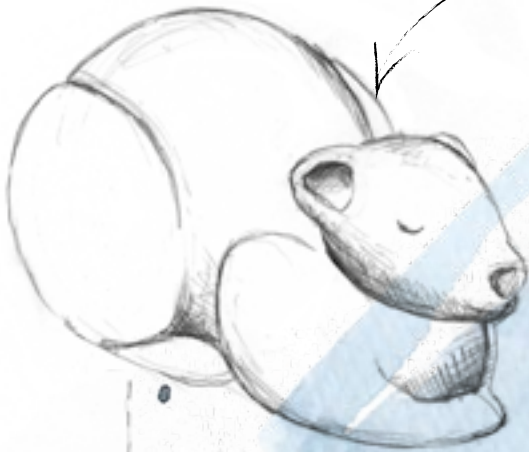

A THERMOFORMED MOULD
FOR A SLEEPY POLAR BEAR.



RITZ CARLTON X PCB CRÉATION

DENIS TOUCHERON

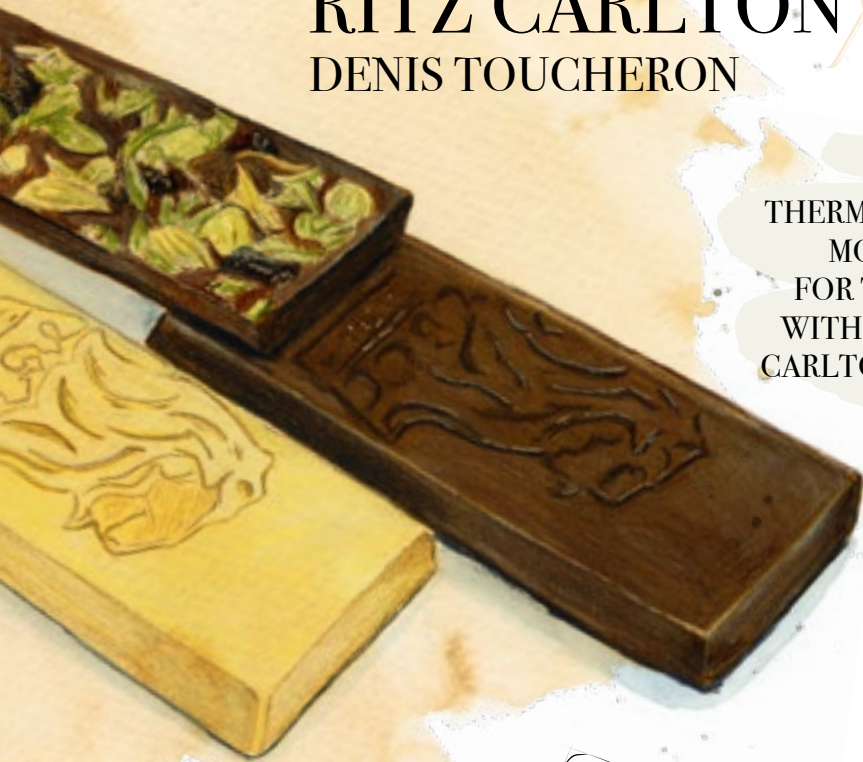

THERMOFORMED
MOULDS
FOR TABLETS
WITH THE RITZ
CARLTON'S LOGO

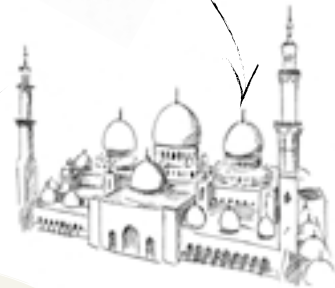
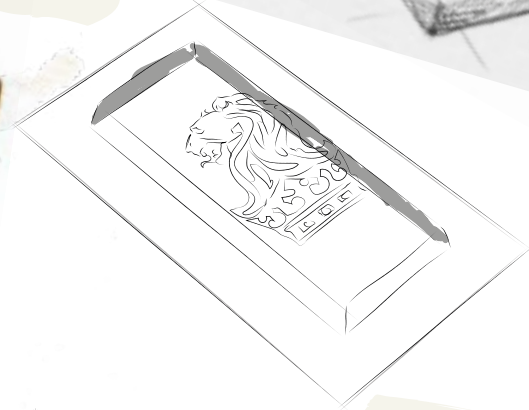
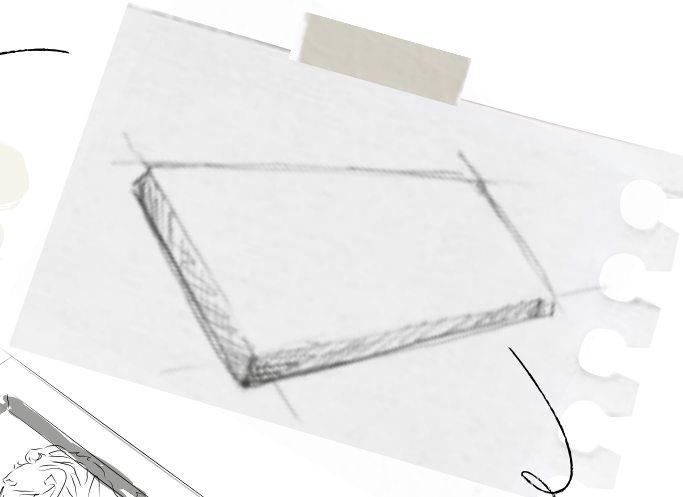

AND ANOTHER
ONE WITH THE
GRAND MOSQUE
OF ABU DHABI

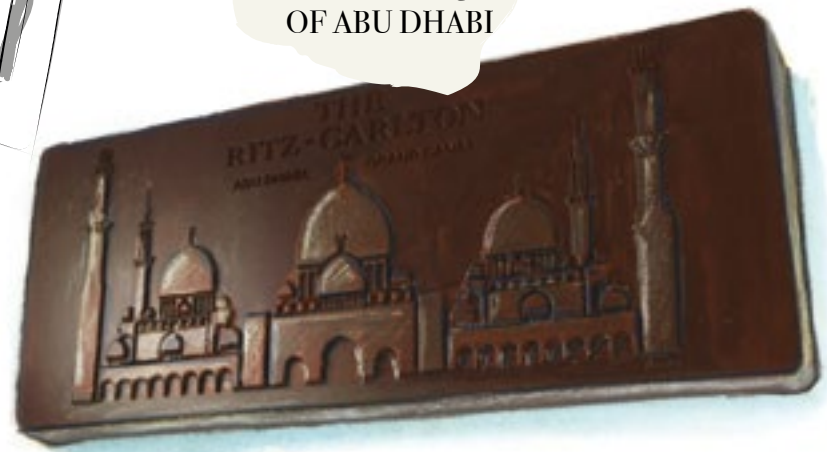
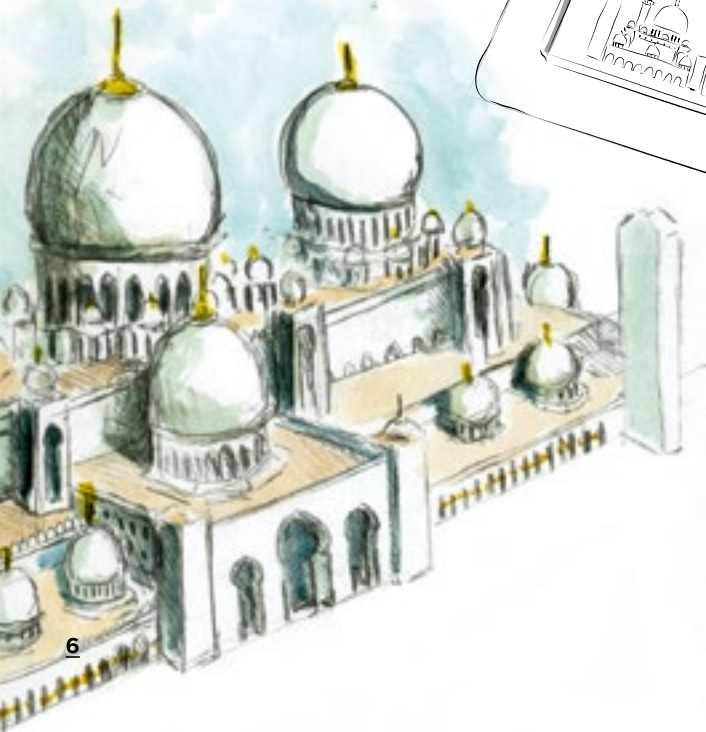

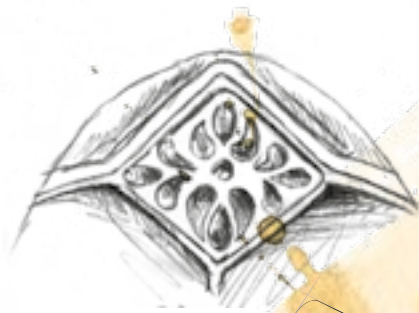

THERMOFORMED
EGG MOULDS WITH
THE RITZ CARLTON'S
LOGO



AND A THERMOFORMED
VERSION FOR
A GOLD LINGOT

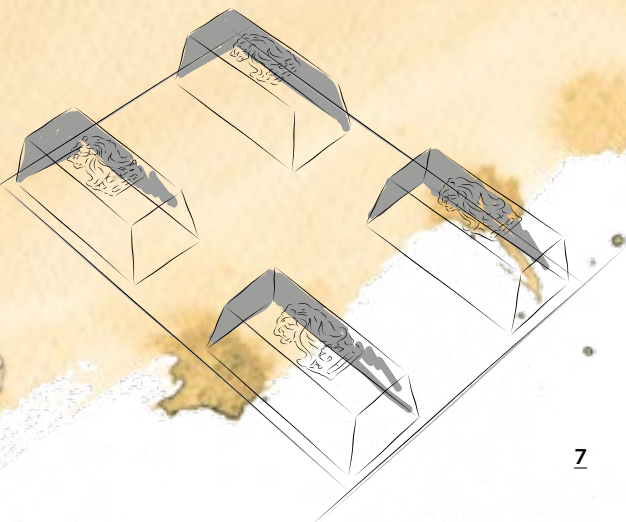

THE MAIN STEPS OF YOUR PROJECT



1

TELL US
YOUR IDEAS



2

CHOOSE YOUR
MODEL



3

CHOOSE YOUR
DESIGN



4

GET OUR
PROPOSALS

By email within 3 to 5 days

CHOOSING YOUR MODEL AND SHAPE

WHICH MODEL WOULD YOU LIKE TO PERSONALIZE?

ANY OTHER IDEAS? ALWAYS ASK, WE DON'T WANT ANY MISUNDERSTANDINGS!

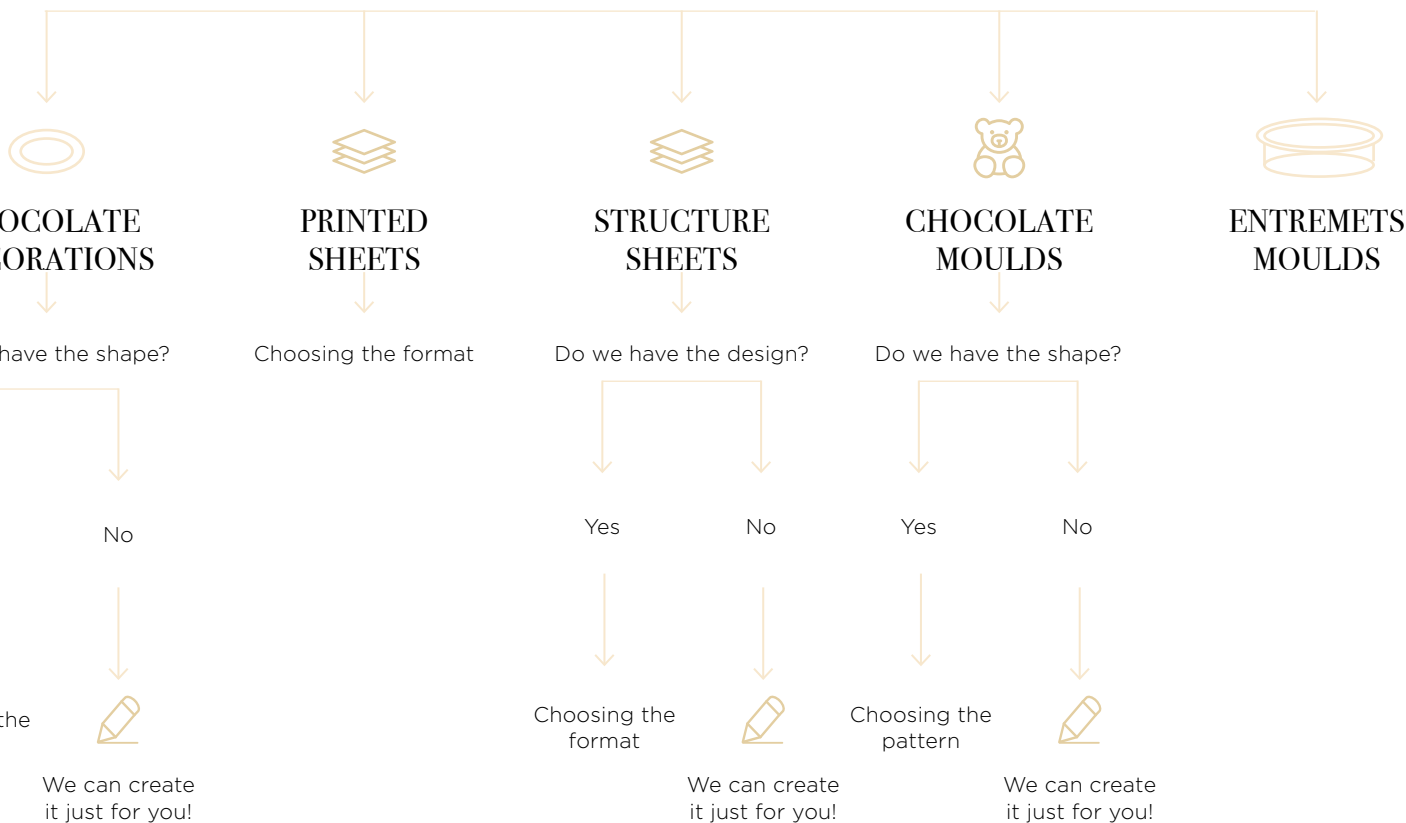



5

VALIDATE



6

RECEIVE A
PROTOTYPE

(Only upon request)



7

PRODUCTION

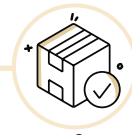

8

DELIVERY

CHOOSING THE DESIGN

WHAT DESIGN WOULD YOU LIKE?

I'D LIKE TO USE MY LOGO

I HAVE AN IDEA OR
A SPECIFIC THEME

I WANT TO CUSTOMIZE A PRODUCT
FROM THE PCB COLLECTION

Do you have your logo?

Do you have a visual?



Send us your
ideas!

Yes

No

Yes

No



Send it to our
team

We can create
it just for you!

Send it to our
team We can create
it just for you!

OUR COLOUR LIBRARY

We have a LOT of colours.

A very large range of E171-free shades, natural shades, non-azo shades, sparkling shades, even dye-free shades, but also colours that can be exported all over the world and can adapt to any market! We are currently preparing a pretty file to show you all of this.







SELECT A PRODUCT



CUSTOMISING MIXED CHOCOLATE DECORATIONS



FREE ARTWORK COSTS

MIXED CHOCOLATE PIECES - POSSIBLE IN 1 COLOUR PRINTING (GOLD) ONLY						
SHAPE	DIMENSIONS	PRINTED BLISTERS per box of 100 sheets		CHOC. PIECES MADE WITH DOSING MACHINE Minimum order per 5 boxes		
		Designs per sheet	Designs per box	Choc. pieces per sheet	Choc. pieces per box	Number of pieces per order
	Round ø20mm Square 18 mm Oval 25 X 15 mm	48 16 of each shape	4800 1600 of each shape	48 16 of each shape	960 320 of each shape	4800 1600 of each shape
	Round ø30mm Square 27 mm Oval 37 X 24 mm	27 9 of each shape	2700 900 of each shape	27 9 of each shape	540 180 of each shape	2700 900 of each shape





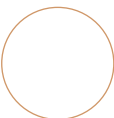

CUSTOMISATION OF CHOCOLATE PIECES











Many other sizes and shapes are available, please contact our team.

SHAPE	DIMENSIONS	TRANSFER SHEETS		CHOCOLATE PIECES			
		FOR STENCIL per 125 sheets	BLISTERS per 100 sheets	STENCIL CHOCOLATE PIECES Minimum of 3 boxes		CHOC. PIECES DOSING MACHINE - Minimum of 10 boxes	
		Designs per sheet	Imprints per sheet	Choc. pieces per sheet	Choc. pieces per box	Choc. pieces per sheet	Choc. pieces per box
	20 X 20 mm	24	176	24	480	176	880
	30 X 30 mm	24	88	24	480	88	440
	40 X 40 mm	12	48	12	240	48	240
	70 X 70 mm	4	24	4	80	24	120
	ø 20 mm	44	76	44	880	76	880
	ø 25 mm	24	108	24	480	108	540
	ø 30 mm	24	88	24	480	88	440
	ø 40 mm	12	48	12	240	48	240

CUSTOMISATION OF CHOCOLATE PIECES

SHAPE		TRANSFER SHEETS		CHOCOLATE PIECES			
		FOR STENCIL per 125 sheets	BLISTERS per 100 sheets	STENCIL CHOCOLATE PIECES Minimum of 3 boxes		CHOC. PIECES DOSING MACHINE - Minimum of 10 boxes	
		Designs per sheet	Imprints per sheet	Choc. pieces per sheet	Choc. pieces per box	Choc. pieces per sheet	Choc. pieces per box
	30 X 10 mm	40	152	40	960	152	760
	40 X 29 mm	12	66	12	240	66	330
	45 X 15 mm	30	90	30	600	90	450
	50 X 7 mm	28	95	28	560	95	475
	55 X 15 mm	30	78	30	600	78	390
	60 X 40 mm	10	32	10	200	32	160
	70 X 15 mm	15	70	15	300	70	350
	70 X 20 mm	20	55	20	400	55	275
	25 X 16 mm	20	135	20	400	135	675
	34 X 17 mm	28	120	28	560	120	600
	39 X 23 mm	28	78	28	560	78	390
	42 X 30 mm	21	66	21	420	66	330
 ÉCLAIR	132 X 32 mm	6	-	6	120	-	-
 MINI-ÉCLAIR	15 X 68 mm	20	-	20	400	-	-
 HEART	30 X 27 mm	24	99	24	480	99	495
 HEART	48 X 44 mm	12	40	12	240	40	200
 BANNER	79 X 33 mm	12	33	12	240	33	165
 BISCUIT	50 X 40 mm	-	45	-	-	45	225
 LABEL	38 X 75 mm	-	30	-	-	30	150
 END OF YULE LOG	80 X 50 mm	8	21	8	160	21	105 (min.10 boxes)
 END OF YULE LOG	80 X 60 mm	4	18	4	80	18	90 (min.10 boxes)
 END OF YULE LOG	68 X 82 mm	4	15	4	80	15	75 (min.10 boxes)
 END OF YULE LOG	75 X 75 mm	-	15	-	-	15	75 (min.10 boxes)
 END OF YULE LOG	85 X 75 mm	4	-	4	80	-	-
 END OF YULE LOG	90 X 85 mm	4	-	4	80	-	-

CUSTOMISATION OF CHOCOLATE PIECES

SHAPE		DIMENSIONS	TRANSFER SHEETS		CHOCOLATE PIECES			
			FOR STENCIL per 125 sheets	BLISTERS per 100 sheets	STENCIL CHOCOLATE PIECES Minimum 3 boxes		CHOC. PIECES DOSING MACHINE Minimum 10 boxes	
			Designs per sheet	Imprints per sheet	Choc. pieces per sheet	Choc. pieces per box	Choc. pieces per sheet	Choc. pieces per box
 END OF YULE LOG	90 X 90 mm	3	12	3	60	12	60 (min.10 boxes)	
 EGG	64,5 X 47,5 mm	8	28	8	160	28	140 (min.10 boxes)	
 STAR	30 X 30 mm	-	108	-	-	108	540 (min.10 boxes)	
 STAR	45 X 45 mm	-	48	-	-	48	240 (min.10 boxes)	
 STAR	61 X 61 mm	-	30	-	-	30	150 (min.10 boxes)	
 STICK	138 X 5 mm	-	72	-	-	72	144 (min.25 boxes)	
 SPOON	108 X 26 mm	-	24	-	-	24	120 (min.20 boxes)	
 MINI-SPOON	80 X 20 mm	-	45	-	-	45	225 (min.20 boxes)	
 WAX SEAL	ø 35 mm	-	63	-	-	63	315 (min.20 boxes)	
 3D HALF-BALL	ø 26 mm	-	63	-	-	63	630 (min.20 boxes)	
 3D HALF-EGG	34 X 23 mm	-	63	-	-	63	630 (min.20 boxes)	



CUSTOMISATION OF STRUCTURE SHEETS

SUPPORT	DIMENSIONS	Pieces per box	Minimum number of boxes per order
PET	4 X 4 cm	1200	4
	36 X 13 cm	250	1
	40 X 25 cm	125	1
	40 X 60 cm	50	1

We can cut any size your heart desires,
please contact our team!



CUSTOMISATION OF TRANSFER SHEETS

SUPPORT	DIMENSIONS	Pieces per box	Minimum number of boxes per order
NYLON	4 X 4 cm	3000	1
	36 X 13 cm	125	1
	40 X 25 cm	125	1
	40 X 60 cm	125	1
PET	40 X 60 cm	125	1
BAKING PAPER	40 X 60 cm	125	1
MACROLON SHEETS	26,5 X 12,5 cm	125	1



CUSTOMISING KITS

Simple to use products for maximum effect, we also offer personalisation of our chocolate kits. Many other kits can be personalised, feel free to contact our team!

CUSTOMISING KITS		BLISTERS & TRANSFER SHEETS		CHOCOLATE PIECES		
SHAPE	DIMENSIONS	Number of pieces per blister/ sheet	Number of pieces per box	Number of pieces per blister or sheet	Number of pieces per box	Minimum of boxes per order
LOLLIPOPS	ø 54 mm	5 pieces	2250 pieces	5 pieces	60 pieces	38 boxes
PUZZLES	190 X 130 mm	1 piece	450 pieces	-	-	-
HALF LIPSTICKS	52 X 12,5 mm	36 pieces	7200 pieces	36 pieces	288 pieces	13 boxes
CREDIT CARDS	85 X 55 mm	5 pieces	625 pieces	5 pieces	100 pieces	3 boxes
CARDS	210 X 105 mm	1 piece	375 pieces	-	-	-
SQUARE CARDS	119,5 X 119,5 mm	1 piece	750 pieces	-	-	-
CD	ø 115 mm	1 piece	375 pieces	-	-	-



CUSTOMISING DRINKS

We offer a range of decorations (chocolate and marshmallow plaquettes) to be placed on the foam of your coffees and hot drinks, or on glasses for your cold ones. Discover our Bar range!

CUSTOMISING DRINKS		MARSHMALLOW PIECES		"EXTRA-THIN" CHOCOLATE PIECES		
SHAPE	DIMENSIONS	Designs per box	Minimum of boxes per order	Choc. pieces per sheet	Choc. pieces per box	Number of pieces per order
	ø 30 mm	288	3	24	480	1440
	ø 40 mm	144	3	12	240	720
	25 X 25 mm	-	-	56	336	3360
	40 X 40 mm	-	-	27	162	1620

You are the Chefs!

Thank you for sharing photos of your creations with your customised products on instagram @pcbcreation



Chocolat Chapon @chocolatchapon (Printed customised blisters) - **Thierry Atlan** @thierry_atlan (Customised blisters for macarons)
L'Éclair de Génie @leclairdegenieofficiel (Customised top of eclairs) - **Alexandre Thabard** @alexthabard (Customised embossed decoration) - **Agathe Olivet** @patisserie_agathe_olivet (Customised chocolate piece) - **Quentin Bailly** @quentinbaillyofficiel (Customised printed sheets for bottles) - **Jean Louis Chiericato** @jeanlouis_chiericato (Silicone mould for customised entremets)
Boulangerie Pâtisserie Hubert @boulangeriehubert (Customised chocolate piece) - **L'Éclat chocolaterie** @leclatchocolaterie (Customised stencil for king's cake)

Thank you for sharing photos of your creations with our products on instagram @pcbcreation



Bricoleurs de Douceurs @bricoleursdedouceurs (088235 - Mould "Calavera") - **Les Artisans Réunis** (050294 - Dry flowers, 088142 crispy wetproof and 074146 decoration "Fête des mères") - **Au Petit Prince** @patisserie.aupetitprince (074125 - Mould "Kits Œufs", 061177-07063 White choc decorations "Eyes") - **Au fond du jardin** @au.fond.du.jardin.strasbourg (074154-074157 - White choc decorations "colors") - **Grahv chocolate** @grahv.chocolate (088236 - Mould "Chauve-souris") - **La maison de la pâtisserie** @patisseriecoms (065148 - Blister "Horloge et aiguilles")

CONTACT US!

Receive your free print voucher and your quotation



PCB Création
1 rue de Hollande
CS 60067

67232 BENFELD CEDEX FRANCE



(33) 03 88 587 336



pcb.creation@
pcb-creation.fr



www.pcb-creation.com



le chocolat
ma thérapie

HP
PASCAL
HAINIGUE



NEW 098267

135 "Biscuités" decorations "P'tits bonhommes" 3 designs 2,7 x 3 cm - N/A: China, Japan, Singapore



"BISCUITÉS" DECORATIONS

Go gastronomic and decorate with our new range of decorations: Biscuités!

Made from a subtle blend of cookie and chocolate, Biscuités decorations add texture and crunch to the world of decor. They have a little taste of home that's sure to make you fall head over heels! The Biscuités decorations can of course be customised with your name or the design of your choice!

Don't hesitate to contact us for more information.



NEW 098268

60 "Biscuités" decorations "Grands flocons" 3 designs ± 5 x 5 cm - N/A: China, Singapore



NEW 098408

40 "Biscuités" ends of yule log 8,5 x 7,5 cm



NEW 098269

60 Biscuités" decorations "Gretel" 2 designs ± 4 x 5 cm - N/A: China, Singapore



NEW 098188

120 "Biscuités" decorations "Croquez-moi" 5 x 4,3 cm
N/A: USA, China, Japan, Qatar, South Korea, Singapore



NEW 098189

120 "Biscuités" decorations
"Petite cuillère" 1,9 x 8,5 cm



"MERINGUÉS" DECORATIONS

Fall in love with our range of "Meringués" decorations and give in to their immaculate colour! Stars, snowflakes, flowers, leaves... these essentials combine purity and delicacy: the ideal harmony to elegantly enhance your desserts.



070413
270 "Meringués" decorations "Petits cristaux"
2,8 x 3,2 cm - N/A: USA, China, Japan, Hong Kong



074267
360 "Meringués" decorations embossed "Petits flocons"
3 designs 2,3 x 2,4 cm N/A: USA, China, Japan, Hong Kong



087058
120 "Meringués" decorations
"Ourson" 2,5 x 3,4 cm
N/A: USA, China, Japan, South Korea, Hong Kong



070409
120 Crystallized "Meringués" decorations "Étoiles" 4 designs - N/A: USA, China, Japan, Hong Kong



074266
150 Crystallized "Meringués" decorations
"Flocon" 4,8 x 4,2 cm - N/A: USA, China, Japan, Hong Kong



070407
140 "Meringués" decorations embossed
"Grands cristaux" 4,35 x 5 cm - N/A: USA, China, Japan, Hong Kong



070408
270 "Meringués" decorations embossed "Petits cristaux"
2,8 x 3,2 cm - N/A: USA, China, Japan, Hong Kong



074263
500 "Meringués" decorations "Petites boules de Noël" 4 designs 1,7 x 2,4 cm
N/A: USA, China, Japan, UAE, Saudi Arabia, Qatar, Kuwait, Bahrain, Oman, South Korea, Hong Kong, Singapore

DECORATIONS



070410

120 "Meringués" decorations "Étoiles" 4 designs - N/A: USA, China, Japan, Hong Kong



070411

150 "Meringués" decorations "Flocon"
4,8 x 4,2 cm - N/A: USA, China, Japan, Hong Kong



070418

160 "Meringués" decorations "Étoile filante" 2 designs - N/A: USA, China, Japan, UAE, Saudi Arabia, Qatar, Kuwait, Bahrain, Oman, South Korea, Hong Kong, Singapore



074258

120 "Meringués" decorations "Étoiles" 4 designs - N/A: USA, China, Japan, UAE, Saudi Arabia, Qatar, Kuwait, Bahrain, Oman, South Korea, Hong Kong, Singapore

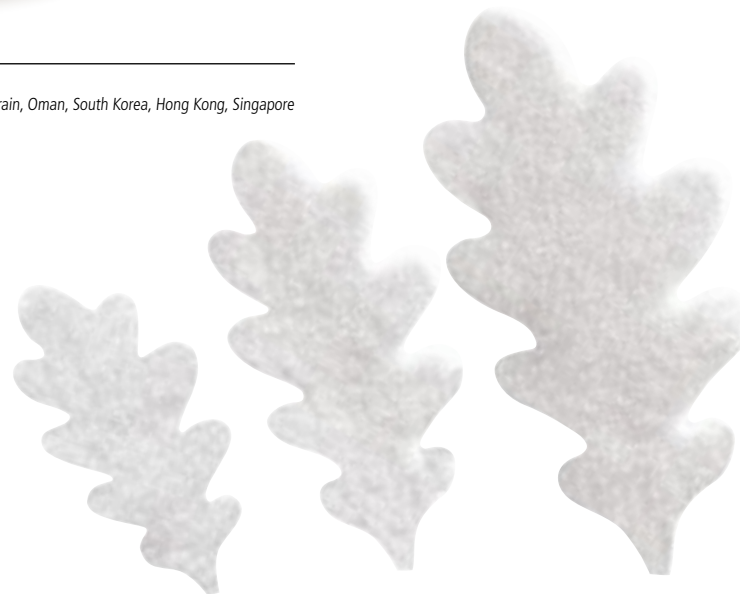

074265

140 Crystallized "Meringués" decorations "Feuilles de chêne" 3 designs - N/A: USA, China, Japan, Hong Kong

DECORATIONS



074127

120 "Meringués" decorations embossed "Grandes Fleurs" ø 4,5 cm 3 designs - N/A: USA, China, Japan, Hong Kong



074126

240 "Meringués" decorations embossed "Petites Fleurs" ø 3 cm 3 designs - N/A: USA, China, Japan, Hong Kong



074262

200 "Meringués" decorations "Ailes de papillons" 2 designs
3,2 x 4,5 cm - N/A: USA, China, Japan, UAE, Saudi Arabia, Qatar, Kuwait,
Bahrain, Oman, South Korea, Hong Kong, Singapore



074128

120 "Meringués" decorations "Fleurs de cerisier" ø 3 cm 6 designs - N/A: USA, China, Japan, UAE, Saudi Arabia, Qatar, Kuwait, Bahrain, Oman, South Korea, Hong Kong



074133

270 "Meringués" decorations "Love" 3 cm 6 designs - N/A: USA, China, Japan, Hong Kong



OPALINES

Discover the finesse and elegance of these crystal decorations.
The magic and light combined in the transparency and brilliance of Isomalt will fascinate your customers and add a ray of light to your creations.

**070400**

32 Opalines "Étoiles bronze" 2 designs
5,7 x 5,4 - 4,3 x 4,1 cm
N/A: USA, China, Japan, Qatar, South Korea,
Hong Kong, Singapore

**070402**

64 Opalines "Feuilles de citron vert" 2,3 x 3,75 cm
N/A: USA, Canada, China, Japan, UAE, Saudi Arabia, Qatar, Kuwait,
Bahrain, Oman, South Korea, Taiwan, Hong Kong

**065316**

32 Opalines bronze \pm \varnothing 5 cm
N/A: USA, China, Japan, Qatar, South Korea, Hong Kong,
Singapore

**065317**

32 Opalines ruby red \pm \varnothing 5 cm
N/A: USA, China, Japan, UAE, Saudi Arabia, Qatar, Kuwait,
Bahrain, Oman, South Korea, Hong Kong

**070403**

32 Opalines "Feuilles de chêne vert"
7,8 x 3,9 cm - N/A: Canada, China, Japan, UAE,
Saudi Arabia, Qatar, Kuwait, Bahrain, Oman,
Hong Kong

**070404**

32 Opalines "Feuilles de chêne orange"
7,8 x 3,9 cm - N/A: China, Japan, Hong Kong,
Singapore

**007273**

32 Snowflakes crystal gold spangled \varnothing 5,5 cm
N/A: USA, China, Japan, UAE, Saudi Arabia, Qatar,
Kuwait, Bahrain, Oman, South Korea, Hong Kong,
Singapore

**007260**

32 Snowflakes crystal silver spangled \varnothing 5,5 cm
N/A: China, Japan, UAE, Saudi Arabia, Qatar, Kuwait,
Bahrain, Oman, South Korea, Hong Kong, Singapore

CRYSTAL
DECORATIONS



HAPPY HALLOWEEN



070346
70 Skulls Dark choc embossed
"Calavera" 3 x 4 cm



070343
130 Bats Dark choc 5 x 2,4 cm



NEW 098290
90 Flasks White choc "Poison" 5 designs - N/A: China, UAE, Saudi Arabia, Qatar, Kuwait, Bahrain, Oman, South Korea, Hong Kong



088222
176 Ghosts White choc
"Bouh" 3 x 2,95 cm

088217
154 Spiders Dark choc "Aragog"
2,9 x 3,1 cm

NEW 098175
150 Small Sugar candy
"Trick or treat" 2 x 4 cm

070355
80 Headstones Dark choc 3 designs



070344
150 Knives and choppers White choc 2 designs



088219
108 Pumpkins tops orange
colored chocolate "Curcurbitacée"
4 x 3,95 cm - N/A: Canada, China,
Japan, Hong Kong



NEW 098173
88 Balls White choc "Jack" ø 3 cm



070354
104 Bones White choc 6 x 2,4 cm

DECORATIONS



087129

110 Decorations Compound "Pains d'épices" 2 designs 3 x 4,5 cm
N/A: China, Japan, UAE, Saudi Arabia, Qatar, Kuwait, Bahrain, Oman



087041

135 Pumpkins White choc "Effrayantes" 4 designs - 3 x 2,7 cm
N/A: USA, China, Japan, South Korea, Hong Kong



088218

140 Pumpkins Dark choc and orange colored chocolate "Jack" 4 designs
N/A: China, Japan



088220

176 Skulls White choc 3 x 2,9 cm



NEW 098296

36 Coffins Dark choc embossed "Squelette" 8,9 x 3 cm



070347

208 Ghosts White choc "Frère et sœurs" 3 designs

087036

208 Skulls Compound "Calavera" 2,25 x 3 cm - 7 designs - N/A: China, Japan, Hong Kong



088028

60 Squares White choc "Happy Halloween" 4 cm - N/A: USA, China, Japan, UAE, Saudi Arabia, Qatar, Kuwait, Bahrain, Oman, South Korea



088100

108 Pumpkins White choc "Happy Halloween" 4 x 3,7 cm - N/A: China, Japan, UAE, Saudi Arabia, Qatar, Kuwait, Bahrain, Oman, South Korea, Hong Kong



088221

117 Skulls Dark choc 2,4 x 2,5 cm



045015

Colored cocoa butter 100% fruit/plant based "Cacao noir" - 200 g

065295

Colored cocoa butter natural origin "Orange" - 200 g
N/A: China, Singapore

Free of colouring • Worldwide • Azo





NEW 098351 ●●●●●
12 Moulds "Trio de citrouilles" for 6 pieces
3 designs 7,2 x 6,2 cm - Th. 7,1 cm
Weight: ± 30 g



For even more terrifying moulds, consider filling the skeleton and skull with white chocolate!



070423

9 Moulds coffin "Six pieds sous terre"
Bottom: 7,9 x 14,6 cm - Th. 3 cm - Cover:
7,9 x 14,6 cm - Th. 1,37 cm
Skeleton: 6,5 x 13,2 cm - Th. 0,8 cm



070390

9 Blisters lollipops "Halloween" and sticks
for 45 prints - 5 designs - Weight: ± 15 g



074321

14 Moulds "Grimoire Halloween"
for 4 pieces 10 x 13 cm - Th. 4 cm
Weight: ± 160 g



088236

12 Moulds "Chauve-souris"
for 6 pieces 10 x 14,2 cm - Th. 4,65 cm
Weight: ± 65 g



NEW **098240**

15 Transfer sheets
"Trick or beer"
7,3 x 7,3 cm

NEW **089001**

10 Moulds "Bouteille
de bière" for 5 pieces
18 x 4,9 cm - Th. 4,9 cm
Weight: ± 55 g



088237

10 Moulds "Fiole" for
5 pieces 14 x 3,4 cm
Th. 6,8 cm - Weight: ± 65 g

088186

15 Transfer sheets "Elixir
magique" 3 designs
3,4 x 2,8 cm - N/A: USA,
China, Japan, UAE, Saudi Arabia,
Qatar, Kuwait, Bahrain, Oman,
South Korea, Singapore

ENTREMETS MOULDS



🍷 🌿 074234

30 Individual entremets moulds
"Citrouille" for 120 pieces
8,5 x 8,9 cm - H. 3,3 cm
Moulds with support jambs



🍷 🌿 070529

30 Individual entremets moulds
"Citrouille" for 120 pieces
ø 7,5 cm - H. 1,8 cm
Moulds with support jambs



🍷 🌿 070511

30 Individual entremets moulds
"Souche" for 120 pieces
ø 7 cm - H. 3,5 cm
Moulds with support jambs

CAMILLE

Lesucy



🍷 🌿 070517

30 Entremets moulds "Souche"
for 30 pieces ø 18 cm - H. 4 cm
Moulds with support jambs

ANGELO

Musa



🍷 🌿 065150

5 Structure sheets pre-folded
"Bois" for cube 10 cm

🍷 🌿 005018

100 Rhodoïde sheets
neutral 10 x 10 cm

🍷 🌿 009952

1 Mould "Cube" for 5 pieces
10 x 10 cm - H. 10 cm

🍷 🌿 009910

1 Inox mould Cube
10 x 10 cm - H. 10 cm



🍷 🌿 074243

30 Entremets moulds "Citrouille"
for 30 pieces 15,8 x 16,5 cm - H. 4,7 cm
Moulds with support jambs

070530

30 Entremets moulds "Citrouille"
for 30 pieces ø 16 cm - H. 4,4 cm
Moulds with support jambs



HAPPY THANKSGIVING

**088054**

110 Rectangles Dark choc "Happy Thanksgiving" 7 x 2 cm • N/A: China, Japan, UAE, Saudi Arabia, Qatar, Kuwait, Bahrain, Oman, South Korea, Taiwan, Hong Kong, Singapore

**088135**

150 Turkeys Milk choc "Glouglou" 3 designs 2,6 x 3 cm • N/A: China, Japan, UAE, Saudi Arabia, Qatar, Kuwait, Bahrain, Oman, Hong Kong

**NEW 098172**

110 Rectangles White Choc "Happy Thanksgiving" 5 x 2,8 cm - N/A: China, Japan, UAE, Saudi Arabia, Qatar, Kuwait, Bahrain, Oman

**070361**

154 Small maple leaves compound "Automne" 3 designs 3,15 x 3,1 cm • N/A: China, UAE, Saudi Arabia, Qatar, Kuwait, Bahrain, Oman

**088055**

96 Squares White choc "Happy Thanksgiving" 4 cm • N/A: China, Japan, UAE, Saudi Arabia, Qatar, Kuwait, Bahrain, Oman, South Korea, Taiwan, Hong Kong, Singapore

**088056**

88 Rounds White choc "Thanks" ø 3 cm • N/A: China, Japan, UAE, Saudi Arabia, Qatar, Kuwait, Bahrain, Oman, South Korea, Taiwan, Hong Kong, Singapore

**070432**

300 Leaves White Choc "Automne" 4 designs - N/A: USA, China, Singapore

**NEW 098288**

132 Pumpkins compound "Feuilles d'automne" 3 designs - N/A: China, UAE, Saudi Arabia, Qatar, Kuwait, Bahrain, Oman, South Korea, Hong Kong, Singapore



ADVENT CALENDARS

This year, PCB Création is offering four Advent Calendars designs to keep food lovers waiting! It consists of a two-panel cardboard case with 24 pre-cut windows and two blisters of 12 shapes each (on the theme of Christmas animals). These blisters to be filled, will showcase the quality of your homemade chocolate.



- 087008**
 10 Advent Calendars "La Fabrique à jouets" to fill - in french
 10 packing boxes book shaped with precut windows, 20 Molds to fill, 12 imprints each
 Size: closed 19 x 21 x 3,5 cm, width open 41,5 cm
 Chocolate weights: ± 6 g



- NEW 098249**
 10 Advent Calendars "Noël enchanté" to fill - in french
 10 packing boxes book shaped with precut windows, 20 Molds to fill, 12 imprints each
 Size: closed 19 x 21 x 3,5 cm, width open 41,5 cm
 Chocolate weights: ± 6 g



- 074334**
 10 Advent Calendars "Santa Express" to fill - in french
 10 packing boxes book shaped with precut windows, 20 Molds to fill, 12 imprints each
 Size: closed 19 x 21 x 3,5 cm, width open 41,5 cm
 Chocolate weights: ± 6 g



- 088057**
 10 Advent Calendars "Le village pain d'épices" to fill
 10 packing boxes book shaped with precut windows, 20 Molds to fill, 12 imprints each
 Size: closed 19 x 21 x 3,5 cm, width open 41,5 cm
 Chocolate weights: ± 6 g



Discover our new Advent calendar concept!

A cardboard case with 24 pre-cut windows which create a book,
It comes with two blister packs which contain 24 boxes to be filled with your most delicious creations.
Size of the boxes to fill: 3,2 x 4,2 cm - H. 2,5 cm



088058
10 Advent Calendars "Un Noël à Versailles" to be filled
10 packing boxes book shaped with pre-cut windows, 20 Molds to fill, 12 imprints each - Dimensions: closed 19 x 21 x 5,5 cm, width open 43,5 cm

074330
10 Advent Calendars "Village de Noël" to be filled
10 packing boxes book shaped with pre-cut windows, 20 Molds to fill, 12 imprints each - Dimensions: closed 19 x 21 x 5,5 cm, width open 43,5 cm

Free of colouring



Worldwide • Azo





Please note the ends of yule log are not shown in real size.

DECORATIONS





 **088148**
 96 Snowflakes Dark choc embossed "Givré" - 3 designs 3,5 x 4 cm





 **088216**
 144 Stars Dark choc embossed "Finesse" 4 designs 3,5 x 3,6 cm

EMBOSSED PIECES



 **060362**
 105 Snowflakes Dark choc, Choc BC and White choc embossed - 3 designs 3,8 x 4,3 cm



 **074209**
 70 Rounds Dark choc embossed "Horloge"
ø 4 cm





 **065031**
 72 Snowflakes White choc embossed
"Blanc" 4 x 4,5 cm





 **NEW 088118**
 72 Embouts CBC avec relief "Chalet" 8,5 x 8,2 cm



 **088023**
 72 Ends of yule log Dark choc embossed "Nuit de Noël"
8,5 x 7,5 cm

 Free of colouring  Worldwide • Azo



 **060357**
 72 Stars Dark choc embossed 4 designs



CHRISTMAS & NEW YEAR

DECORATIONS



060488

63 Balls White choc crystallised bronze ø 3 cm - N/A: USA, China, Japan, Qatar, South Korea, Singapore



NEW 098199

63 Balls White choc crystallised gold ø 3 cm - N/A: USA, China, Japan, Qatar, South Korea, Singapore



065291

63 Balls White choc crystallised red ø 3 cm - N/A: USA, China, Japan, South Korea, Singapore



000222

63 Balls White choc coated bronze ø 2,6 cm - N/A: USA, China, Japan, Qatar, South Korea, Singapore



065285

63 Balls White choc coated red ø 2,6 cm - N/A: USA, China, Japan, Qatar, South Korea, Singapore



070478

63 Balls White choc coated dark green ø 2,6 cm - N/A: USA, China, Japan, Qatar, South Korea, Singapore



050246

63 Balls White choc coated light green ø 2,6 cm - N/A: USA, China, Japan



NEW 098196

63 Balls White choc coated gold ø 2,6 cm - N/A: USA, China, Japan, Qatar, South Korea, Singapore



000218

63 Balls White choc coated copper ø 2,6 cm - N/A: USA, China, Japan, Qatar, South Korea, Singapore



060487

63 Balls White choc crystallised bronze ø 2,6 cm - N/A: USA, China, Japan, Qatar, South Korea, Singapore



NEW 098198

63 Balls White choc crystallised gold ø 2,6 cm - N/A: USA, China, Japan, Qatar, South Korea, Singapore



065290

63 Balls White choc crystallised red ø 2,6 cm - N/A: USA, China, Japan, South Korea, Singapore



NEW 098197

63 Balls White Choc crystallised gold ø 2 cm - N/A: USA, China, Japan, Qatar, South Korea, Singapore



065289

63 Balls White Choc crystallised red ø 2 cm - N/A: USA, China, Japan, South Korea, Singapore



060489

63 Balls White Choc crystallised bronze ø 2 cm - N/A: USA, China, Japan, Qatar, South Korea, Singapore



000221

63 Balls White Choc coated bronze ø 2 cm - N/A: USA, China, Japan, Qatar, South Korea, Singapore



NEW 098195

63 Balls White choc coated gold ø 2 cm - N/A: USA, China, Japan, UAE, Saudi Arabia, Qatar, Kuwait, Bahrain, Oman, South Korea



070477

63 Balls White choc coated dark green ø 2 cm - N/A: USA, China, Japan, Qatar, South Korea, Singapore



065284

63 Balls White Choc coated red ø 2 cm - N/A: USA, China, Japan, South Korea

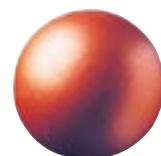

000217

63 Balls White Choc coated copper ø 2 cm - N/A: USA, China, Japan, Qatar, South Korea, Singapore



050250

63 Balls White Choc coated light green ø 2 cm - N/A: USA, China, Japan



DECORATIONS



070495
88 Balls White choc "Rose de Noël" 2 designs ø 3 cm
N/A: China, Japan



060480
88 Balls Dark choc "Noël bronze" 3 designs ø 3 cm
N/A: USA, China, Japan, UAE, Saudi Arabia, Qatar, Kuwait, Oman, Bahrain, South Korea, Singapore



087021
88 Balls Dark choc "Baroque" 2 designs ø 3 cm
N/A: USA, China, Japan, UAE, Saudi Arabia, Qatar, Kuwait, Bahrain, Oman, South Korea, Singapore



070497
88 Balls White choc "Flocon" 3 designs ø 3 cm - N/A: USA, China, Japan, UAE, Saudi Arabia, Qatar, Kuwait, Bahrain, Oman, South Korea, Singapore



NEW 098150
88 Balls Dark choc "Moka" 3 designs ø 3 cm - N/A: China, Singapore



065097
88 Balls White choc "Noël nordique" 3 designs ø 3 cm
N/A: China, Japan



074232
88 Balls White choc "Candy cane" ø 3 cm - N/A: China, Japan, Singapore



NEW 098149
88 Balls White choc "Oslo" 3 designs ø 3 cm - N/A: China, Japan



070499
88 Balls Dark choc "Vitrail" 3 designs ø 3 cm
N/A: USA, China, Japan, UAE, Saudi Arabia, Qatar, Kuwait, Bahrain, Oman, South Korea, Singapore



088031
88 Balls White choc "Kelsch" 3 designs ø 3 cm - N/A: China, Japan, Hong Kong



088030
88 Balls White choc "Hiver pourpre" 3 designs ø 3 cm - N/A: USA, China, Japan, UAE, Saudi Arabia, Qatar, Kuwait, Bahrain, Oman, South Korea, Singapore



NEW 098174
88 Balls White choc "Dorées" 2 designs ø 3 cm - N/A: USA, China, Japan, Qatar, South Korea, Singapore



DECORATIONS



088130
63 Balls Dark choc "Effet truffe" ø 2 cm



088131
63 Balls Dark choc "Effet truffe" ø 2,6 cm



088132
63 Balls White choc "Neige" ø 2 cm



088133
63 Balls White choc "Neige" ø 2,6 cm



088029
72 Christmas balls White choc "Graphique" 3 designs 3 x 3,7 cm - N/A: USA, China, Japan, Qatar, South Korea, Singapore



NEW 098200
72 Christmas balls White choc "Rouge et or" 3 designs 3 x 3,7 cm
N/A: USA, China, Japan, Qatar, South Korea, Singapore



002748
72 Christmas balls White choc "Rouge" 3 designs 3 x 3,7 cm •
N/A: USA, Canada, China, Japan, UAE, Saudi Arabia, Qatar, Kuwait, Bahrain, Oman, South Korea, Singapore



074203
63 Grelots White choc coated bronze ø 2,6 cm
N/A: USA, China, Japan, Qatar, South Korea, Singapore



060484
72 Christmas balls Dark choc "Cuivre étincelant" 3 designs 3 x 3,7 cm - N/A: USA, China, Japan, UAE, Saudi Arabia, Qatar, Kuwait, Bahrain, Oman, South Korea, Singapore



036124
63 Balls Dark choc "Bilbo" 3 designs ø 2,6 cm
N/A: USA, China, Japan, Qatar, South Korea, Singapore



060493
54 Penguins White choc 2,3 x 3,6 cm
N/A: USA, China, South Korea, Singapore



060494
54 Santas White choc 2,3 x 3,6 cm - N/A: China, Singapore



070281
88 Gifts Dark choc 2 designs 2,2 x 2,2 cm
N/A: USA, China, Japan, UAE, Saudi Arabia, Qatar, Kuwait, Bahrain, Oman, South Korea, Singapore



074283
126 Gifts Dark & White choc 2 designs 3,2 x 3,2 cm
N/A: USA, China, Japan, Qatar, South Korea, Singapore



Free of colouring Worldwide • Azo



DECORATIONS



003584
48 Stars Dark choc 3D 4,6 x 4,6 cm



074282
70 Chalets Dark choc 3D 2,5 x 2,5 cm



074279
72 Christmas trees Dark choc 3D 2,5 x 3 cm



074280
72 Christmas trees Choc BC 3D 2,5 x 3 cm



074281
72 Christmas trees White choc 3D 2,5 x 3 cm



074284
88 Chestnuts Milk choc 3D 3 x 2,6 cm - N/A: USA, China, Japan, South Korea, Singapore



087103
63 Hazelnuts Milk choc 3D ø 2,6 cm - N/A: USA, China, Japan, UAE, Saudi Arabia, Qatar, Kuwait, Bahrain, Oman, South Korea, Singapore



088226
176 Hazelnuts Milk choc "Striées" 3D 2,9 x 3 cm



088227
140 Acorns Milk choc 3D 2,85 x 3,5 cm



088223
70 Bears White choc "Teddy" 3D 2,6 x 3,7 cm



088224
70 Bears Choc BC "Teddy" 3D 2,6 x 3,7 cm



088225
70 Bears Milk choc "Teddy" 3D 2,6 x 3,7 cm



NEW 098294
72 Porcini mushrooms Milk choc 3D 2,65 x 3,36 cm



NEW 098292
72 Birds White choc 3D ± 2,5 x 3,6 cm - N/A: USA, China, Japan, UAE, Saudi Arabia, Qatar, Kuwait, Bahrain, Oman, South Korea



060491
88 Mushrooms White choc "Rouge" 3 designs 3D ø 3 cm N/A: China, Singapore



060492
88 Mushrooms Dark choc "Bronze" 3 designs 3D ø 3 cm N/A: USA, China, Japan, Qatar, South Korea, Singapore



060250
88 Mushrooms White choc "Caramel" 3 designs 3D ø 3 cm



DECORATIONS



074219
80 Small mushrooms White choc
"Lutin" 1,5 x 3 cm - N/A: China,
Japan, UAE, Saudi Arabia, Qatar,
Kuwait, Bahrain, Oman



070124
91 Mini-Mushrooms White choc 3 designs • N/A: UAE, Saudi
Arabia, Qatar, Kuwait, Bahrain, Oman



065182
108 Mushroom tops
Compound ø 2,5 cm
N/A: China, Singapore



060502
190 Mini-sticks White Choc "Candy"
3 designs 5 x 0,6 cm - N/A: China, Japan, UAE, Saudi
Arabia, Qatar, Kuwait, Bahrain, Oman



070067
176 Mushrooms Choc BC "Todds" 2 designs • N/A: UAE, Saudi
Arabia, Qatar, Kuwait, Bahrain, Oman



NEW 098275
104 Bears Choc BC "Cadeaux" 2 designs
2,6 x 2,9 cm - N/A: China, Japan



070419
120 Vintage toys Choc BC 5 designs - N/A: China, Singapore



060272
150 Crystallised Raspberry
snowflakes 4,2 x 4,8 cm



060255
56 Reindeers Choc BC 5,2 x 6,1 cm



070063
84 Reindeers Choc BC "Kawai" 4,1 x 5 cm
• N/A: UAE, Saudi Arabia, Qatar, Kuwait, Bahrain,
Oman



060256
128 Biscuits Choc BC "En famille" 4 designs 2,6 x 4,3 cm



070120
90 Gingerbread houses Milk choc "Pain d'épice" 2 designs • N/A: UAE, Saudi Arabia,
Qatar, Kuwait, Bahrain, Oman

Free of colouring • Worldwide • Azo



070283
78 Polar bears White choc
2,4 x 3,8 cm



087107
2 Blisters "Pomme de pin" so 108 prints to
create 12 pine cones ± 4 x 5 cm

DECORATIONS

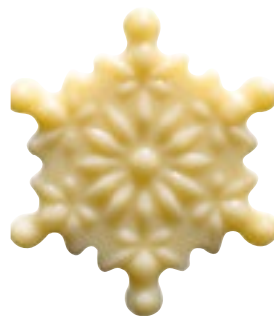

070349
120 Small snowflakes White choc
3,5 x 4 cm



000256
154 Christmas trees Dark choc 4 designs 2,7 x 3,5 cm
N/A: UAE, Saudi Arabia, Qatar, Kuwait, Bahrain, Oman



070064
36 Skis "Bois" Choc BC
1,5 x 13,7 cm



060276
70 Snowflakes embossed White choc ø 5 cm



004904
56 Christmas trees Dark choc "Bulles" 5 x 5,5 cm



070351
60 Large snowflakes White choc 5 x 5,7 cm



070352
60 Large snowflakes Dark choc 5 x 5,7 cm



036115
60 Antlers Choc BC 2 designs 2,5 x 5,2 cm



070350
120 Small snowflakes Dark choc
3,5 x 4 cm

Free of colouring • Worldwide • Azo

DECORATIONS

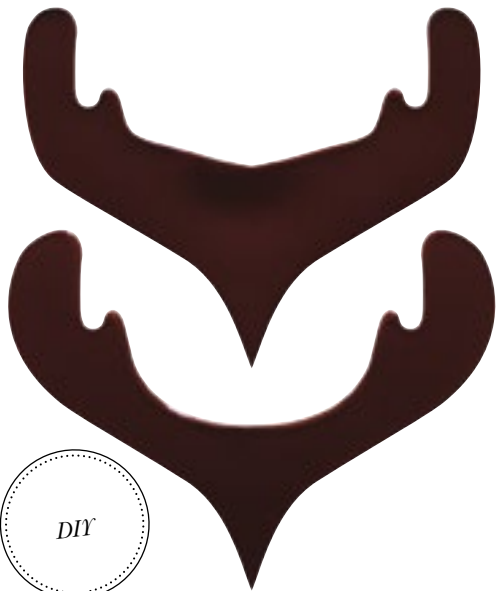

NEW 098273
 140 Reindeer heads White choc
 "Niko" 3,3 x 3,3 cm



070398
 162 Snowflakes Dark choc, Choc BC and White choc 3,7 x 3,4 cm

010714
 1 Stencil for reindeer antlers 12 prints 3 designs 5 x 6 cm



060518
 143 Acorns Compound "Scintillants"
 2 designs 1,8 x 2,5 cm - N/A: USA, China,
 Japan, UAE, Saudi Arabia, Qatar, Kuwait,
 Bahrain, Oman, South Korea, Singapore



070345
 143 Acorns Choc BC 1,8 x 2,5 cm



036102
 144 Christmas trees Dark choc "Mon beau sapin" 4 designs



004873
 150 Snowflakes White choc 4,2 x 4,8 cm



070121
 56 Reindeers Dark choc "Rudolph"
 5,2 x 6,1 cm • N/A: UAE, Saudi Arabia, Qatar,
 Kuwait, Bahrain, Oman



065297
 60 Small pine cones Milk choc
 3 x 3,5 cm



074247
 453 Christmas trees extra thin Dark choc, Choc BC and White choc - 9 designs - 2,5 x 3 cm - 3 x 3 cm - 4 x 4 cm

Free of colouring • Worldwide • Azo



DECORATIONS



NEW 098283
128 Santa Claus White choc
"Hello" 3 x 4,5 cm - N/A: China,
Japan, Singapore



060504
84 Santa Claus heads White choc
3,8 x 5 cm - N/A: China, Japan, Singapore



087040
90 Decorations White choc "Père Noël et Bonhomme de neige" 2 designs
N/A: China, Japan, Hong Kong



NEW 098282
128 Santa Claus heads White choc
"Bouclettes" 3 x 4,5 cm
N/A: China, Japan, Singapore



088061
90 Santa heads White choc
3,6 x 4,5 cm - N/A: UAE, Saudi Arabia,
Qatar, Kuwait, Bahrain, Oman



070433
110 Signs White choc "Père Noël" 3 designs 3 x 4,4 cm
N/A: China, Singapore



070136
70 Santa Claus heads White choc
4,6 x 5 cm • N/A: UAE, Saudi Arabia, Qatar, Kuwait,
Bahrain, Oman



NEW 098176
140 Stamps White choc 2 designs 3,3 x 4,5 cm
N/A: China, Japan



088062
80 Santas White Choc "Sur son traîneau"
4,5 x 4,1 cm - N/A: UAE, Saudi Arabia, Qatar, Kuwait,
Bahrain, Oman



088063
90 Snowmen White Choc "Sur son traîneau"
3,85 x 4,5 cm - N/A: UAE, Saudi Arabia, Qatar,
Kuwait, Bahrain, Oman

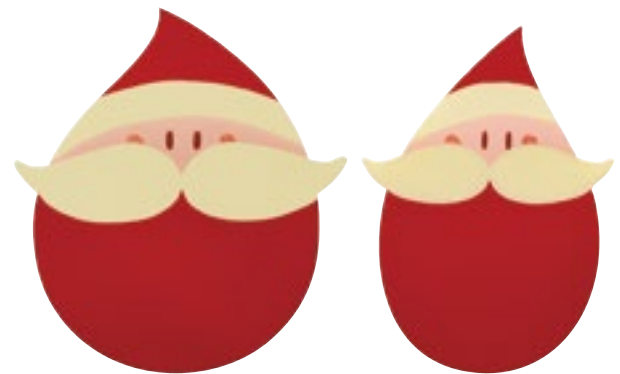

065205
140 Drops White choc "Tête de Père Noël" 2 designs - N/A: China, Japan, Singapore

DECORATIONS



070492
176 Rounds White choc "Candy" 4 designs ø 2 cm
N/A: USA, China, Singapore



065082
300 Christmas balls White choc "Acidulé" 5 designs 1,8 x 2,2 cm
N/A: USA, China



060259
176 Rounds White choc "Sucre d'orge" 3 designs ø 3 cm
N/A: USA, China



NEW 098271
108 Mushrooms White choc "Choupis" 9 designs 2,3 x 2,9 cm - N/A: China, Japan, Hong Kong



NEW 098274
234 Christmas trees White choc "Fluffy" 2 designs 2,5 x 2,55 cm - N/A: China, Japan, Hong Kong



065175
300 Snowmen White choc 4 designs 1,4 x 2,6 cm
N/A: USA, China

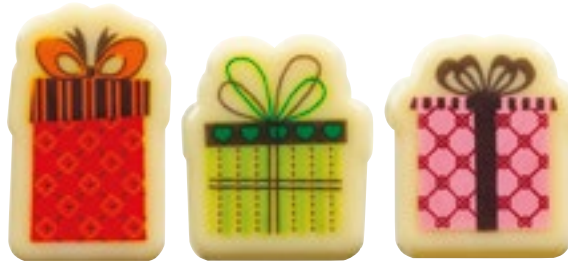

070114
160 Gifts White choc "Noël" 12 designs •
N/A: Canada, China, UAE, Saudi Arabia, Qatar, Kuwait, Bahrain, Oman, South Korea



NEW 098183
140 Bears White choc "Frileux" 2 designs
2,4 x 3,8 cm - N/A: China, Japan



060281
35 Snowflakes White Choc "Vert et Rouge"
ø 5 cm - N/A: USA, China



065186
72 Christmas trees White choc
to stick in 5,7 x 3,9 cm
N/A: USA, China, Japan



060263
50 Christmas trees Barley grass
3,4 x 5 cm - N/A: USA, China



088060
156 Christmas stocks Compound "Noël" 5 designs -
N/A: China, Japan, UAE, Saudi Arabia, Qatar, Kuwait, Bahrain,
Oman, Hong Kong

Free of colouring • Worldwide • Azo



DECORATIONS



NEW 098286

112 Santa Claus legs White choc 5 designs- N/A: USA, China, Japan, Hong Kong



088098

140 Santa Claus White choc "En action" 5 designs- N/A: USA, China, Japan, UAE, Saudi Arabia, Qatar, Kuwait, Bahrain, Oman, South Korea, Hong Kong



NEW 098284

168 Decorations White choc "Trio de Noël" 3 designs - N/A: China, Japan



087044

208 Santa belt buckle compound 2,5 cm
N/A: China, Japan, Hong Kong



070195

110 Snowmen White choc
2,6 x 5 cm •
N/A: UAE, Saudi Arabia, Qatar,
Kuwait, Bahrain, Oman, Taiwan



074285

120 Nutcrackers Dark choc
2,5 x 5 cm - N/A: USA,
China, Japan, UAE, Saudi
Arabia, Qatar, Kuwait, Bahrain,
Oman, South Korea, Singapore



NEW 098289

120 Decorations White choc "Personnages hivernaux" 5 designs- N/A: China, Japan, Hong Kong



NEW 098177

120 Decorations White choc "Lutins de Noël" 3 designs - N/A: China, Japan, Hong Kong



088059

168 Small penguins White choc "Frileux" 3 designs
- N/A: China, Japan, UAE, Saudi Arabia, Qatar, Kuwait,
Bahrain, Oman, Hong Kong



NEW 098293

108 Snowflakes White choc "Élégance"
4,5 x 3,8 cm

Free of colouring Worldwide • Azo

(098286 - Santa Claus legs White choc
+ 098313 - Silicone mould "Bûche
chalet" + 074339 Velvet spray
"Chocolat" + 088269 "Neige Decor")



(087016 - Entremets mould "Sapin"
+ 088099 - Gingerbread White
choc "Les gourmands")



DECORATIONS



088099

120 Gingerbreads White choc "Les gourmands" 3 designs - N/A: China, Japan, South Korea



070070

80 Gingerbreads White choc "Père et Mère Noël" 5 designs • N/A: UAE, Saudi Arabia, Qatar, Kuwait, Bahrain, Oman, Taiwan

060270

80 Gingerbreads White choc "Père et Mère Noël" 5 designs - N/A: USA, China



060254

108 Reindeer heads White Choc 3,6 x 4 cm



060271

90 Gingerbread houses White choc "Pain d'épices" 2 designs



087138

182 Gingerbreads White Choc "Pain d'épices" 3 designs - N/A: USA, China, Japan, South Korea



065183

60 Bears Choc BC "Emmitouflés" 3 x 3,8 cm - N/A: China, Singapore



070131

70 Rounds Choc BC "Rodolphe" ø 5 cm • N/A: UAE, Saudi Arabia, Qatar, Kuwait, Bahrain, Oman



065179

60 Gingerbread houses White Choc "Gretel" 3 designs N/A: China, Japan



087055

150 Small Sugar candy White choc 2 x 4 cm - N/A: China, Japan

087056

56 Sugar candy White choc 3,4 x 9,5 cm - N/A: China, Japan

DECORATIONS



060520

100 Reindeers heads Choc BC "Poro" 3,2 x 4,5 cm
N/A: USA, China, Japan, UAE, Saudi Arabia, Qatar, Kuwait,
Bahrain, Oman, South Korea, Singapore



074204

96 Stars compound "Dorées" 4 x 4,5 cm
N/A: USA, China, Japan, Qatar, South Korea,
Singapore



087139

66 Bears Dark Choc "Sur la banquise" 2 designs



045717

90 Teddy bears White choc "Blanc"
4,1 x 5,5 cm

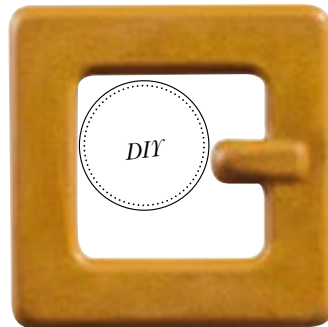

087043 ●●●●

2 Blisters "Boucle de ceinture" so 96 prints
4 x 4 cm - N/A: China, Japan, Hong Kong



087140

66 Bears Choc BC "Sur la banquise" 2 designs



087141

66 Bears White Choc "Sur la banquise" 2 designs



065063

56 Reindeers Milk choc "Rudolphe" 5,2 x 6,1 cm



074296

130 Bottles Dark
choc 2 x 5,2 cm
N/A: UAE, Saudi
Arabia, Qatar, Kuwait,
Bahrain, Oman



074287

182 Moons and stars compound 4 designs
N/A: USA, China, Japan, UAE, Saudi Arabia, Qatar, Kuwait,
Bahrain, Oman, South Korea, Singapore



004843

60 Barriers Dark choc "3 branches" 5,6 x 4,6 cm

(065063 - Reindeers Milk choc
"Rudolphe" + 070587 - Yule log mould
"Gouttière" + 045656 Crunchies ruby +
098396 Stencil "Envolée")



DIY

NEW 098265 ●●●●

18 Blisters "Grands flocons"
so 18 prints ø 15,5 cm



CHRISTMAS AND NEW YEAR

DECORATIONS



065111

96 Stars White choc "Graphique" 2 designs 4,3 x 4,5 cm - N/A: China, Japan, UAE, Saudi Arabia, Qatar, Kuwait, Bahrain, Oman



NEW 098201

216 Stars Dark choc "Rouge et or" 4 designs 3 x 3 cm - N/A: USA, China, Japan, UAE, Saudi Arabia, Qatar, Kuwait, Bahrain, Oman, South Korea, Singapore



060260

252 Stars Mango, Strawberry and Raspberry
3 designs 3 x 2,8 cm - N/A: Taiwan



045687

120 Stars Raspberry 4 designs

NEW

088105

216 Stars White choc "Acidulé" 4 designs 3 x 3 cm
N/A: USA, China, Japan



065199

186 Stars White choc "Colorées" 3 designs - N/A: USA, China, Japan



045647

120 Stars Crystallized White choc 4 designs

DECORATIONS



036099
120 Stars Dark choc "Firmament" 4 designs

036100
120 Stars Choc BC "Firmament" 4 designs

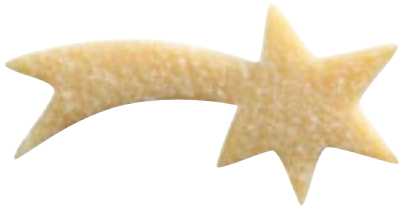

074292
150 Shooting stars Crystallized White choc 6,6 x 3,5 cm

003688
120 Stars Dark choc "Arabesques" 2 designs 3,45 x 3,6 cm

088228
80 Stars Dark choc "Facettes" 4,5 cm

008670
Stars Dark choc shiny bronze
1,8 x 1,4 cm - 200 g
N/A: USA, China, Japan, UAE,
Saudi Arabia, Qatar, Kuwait,
Bahrain, Oman, South Korea,
Singapore



003541
186 Stars Dark choc, Milk choc and White choc 3 designs

088229
60 Stars Dark choc "Facettes" 7,5 cm

060516
120 Stars Dark choc "Pluie d'étoiles" 4 designs
N/A: USA, China, Japan, UAE, Saudi Arabia, Qatar, Kuwait, Bahrain,
Oman, South Korea, Singapore

Free of colouring • Worldwide • Azo



DIY

🌿 087064 ● ● ● ● ●
10 Blisters "Étoile filante"
so 50 prints 20 x 7,8 cm



Let's
eat
cake!

DECORATIONS



074352

110 Rectangles CN "Merry Christmas" 7 x 2 cm - N/A: USA, China, Japan, UAE, Saudi Arabia, Qatar, Kuwait, Bahrain, Oman, South Korea, Singapore



074298

110 Rectangles Dark choc "Happy Holidays" 7 x 2 cm - N/A: UAE, Saudi Arabia, Qatar, Kuwait, Bahrain, Oman



088042

110 Rectangles White choc "Merry Christmas" 7 x 2 cm - N/A: China, Japan, Hong Kong



NEW 098184

140 Squares Dark choc "Happy Holidays" 3,5 cm - N/A: China, Singapore



088040

140 Squares White choc "Season's greetings" 3,5 cm - N/A: China, Japan, Hong Kong



088045

96 Squares Compound "Christmas" 4 cm - N/A: China, Japan, Hong Kong



Customize all our products in your language!

CHOCOLATE PIECES



088044

140 Squares Choc BC "Christmas decoration" 3,5 cm - N/A: China, Japan, Hong Kong



NEW 098181

70 Hearts White choc "Merry Christmas" 5,1 x 5,2 cm - N/A: China, Japan



060467

96 Rounds Dark choc "Joyeux Noël" ø 4 cm
N/A: USA, China, Japan, UAE, Saudi Arabia, Qatar, Kuwait, Bahrain, Oman, South Korea, Singapore



074300

96 Rounds Dark choc "Merry Christmas" ø 4 cm - N/A: UAE, Saudi Arabia, Qatar, Kuwait, Bahrain, Oman



074302

63 Wax seals Compound "Merry Christmas" ø 3,5 cm • N/A: UAE, Saudi Arabia, Qatar, Kuwait, Bahrain, Oman



087042

63 Wax seals Compound "Merry Christmas" ø 3,5 cm - N/A: China, Japan



NEW 098297

120 Squares White choc "Copenhagen" 3 designs 3,5 cm
N/A: China, Japan



074255
4 Blisters "Horloge Tic Tac"
so 12 prints ø 15,5 cm

DECORATIONS

Happy New Year

070471

70 Rectangles White choc "Happy New Year" 7 x 1,5 cm



070472

55 Rectangles Dark choc "Happy New Year Stars" 7 x 2 cm - N/A: UAE, Saudi Arabia, Qatar, Kuwait, Bahrain, Oman



088064

110 Rectangles Dark choc "Happy New Year" 7 x 2 cm • N/A: China, UAE, Saudi Arabia, Qatar, Kuwait, Bahrain, Oman



070463

55 Rectangles Dark choc "Happy New Year" 7 x 2 cm - N/A: UAE, Saudi Arabia, Qatar, Kuwait, Bahrain, Oman



088046

88 Rounds Dark choc "Happy new year" ø 3 cm N/A: USA, China, Japan, UAE, Saudi Arabia, Qatar, Kuwait, Bahrain, Oman, South Korea, Singapore



070464

88 Rounds Dark choc "Horloge" ø 3 cm - N/A: UAE, Saudi Arabia, Qatar, Kuwait, Bahrain, Oman

Bonne année

065116

120 Rectangles White choc "Bonne Année" 5 x 1,7 cm - N/A: USA, China, Japan, UAE, Saudi Arabia, Qatar, Kuwait, Bahrain, Oman, South Korea, Singapore



088101

50 Rectangles White choc "Shiny new year" 4 x 6 cm - N/A: USA, China, Japan, UAE, Saudi Arabia, Qatar, Kuwait, Bahrain, Oman, South Korea, Hong Kong, Singapore



074296

130 Bottles Dark choc 2 x 5,2 cm - N/A: UAE, Saudi Arabia, Qatar, Kuwait, Bahrain, Oman



003300

88 Rounds Dark choc "Horloge" ø 3 cm - N/A: USA, China, Japan, UAE, Saudi Arabia, Qatar, Kuwait, Bahrain, Oman, South Korea, Singapore



087037

2 Blisters "Horloge et aiguilles" 36 prints (12 clocks) 3 designs ø 11,2 cm - N/A: China, Japan, Hong Kong

Free of colouring • Worldwide • Azo • Usable chocolates

NEW YEAR DECORATIONS

(098270 - Ends of yule log "Boule à neige" + 060233 - Yule log mould "Ondes" + 087056 Candy canes White choc + 087055 Small Candy canes White choc + 008670 Stars Dark choc shiny bronze)



Please note the ends of yule log are not shown in real size.

DECORATIONS

ENDS OF YULE LOG



070127

60 Ends of yule log White choc "Vortex" ø 6 cm • N/A: UAE, Saudi Arabia, Qatar, Kuwait, Bahrain, Oman



045776

40 Ends of yule log Choc BC "Strates" 8 x 6 cm



NEW 098343

60 Ends of yule log Dark choc "Coupe" 8,2 x 7 cm



065211

75 Ends of yule log Dark Choc "Joyeuses Fêtes" 8,2 x 6,8 cm
N/A: USA, China, Japan, UAE, Saudi Arabia, Qatar, Kuwait, Bahrain, Oman, South Korea, Singapore



070458

75 Ends of yule log Choc BC "Casse Noisette" 8,5 x 7,5 cm
N/A: USA, China, Japan, UAE, Saudi Arabia, Qatar, Kuwait, Bahrain, Oman, South Korea, Singapore



060402

40 Ends of yule log White Choc "Rennes" 2 designs 8,5 x 8 cm - N/A: USA, China, South Korea, Singapore



NEW 098270

40 Ends of yule log Dark choc "Boule à neige" 8,8 x 7,45 cm
N/A: USA, China, Japan, UAE, Saudi Arabia, Qatar, Kuwait, Bahrain, Oman, South Korea, Singapore

Free of colouring Worldwide • Azo



(098340 - Ends of yule log "Ondulation"
+ 088193 - Yule log moulds "Plissée"
+ 074292 Shooting stars White
choc crystallised)





Please note the ends of yule log are not shown in real size.

DECORATIONS





 **036063**
 75 Ends of yule log Extra thin Dark choc 8,5 x 7,5 cm



 **036064**
 75 Ends of yule log Extra thin Choc BC 8,5 x 7,5 cm





 **036065**
 75 Ends of yule log Extra thin White choc 8,5 x 7,5 cm





 **003870**
 18 Ends of yule log Dark choc 8,7 x 9,5 cm

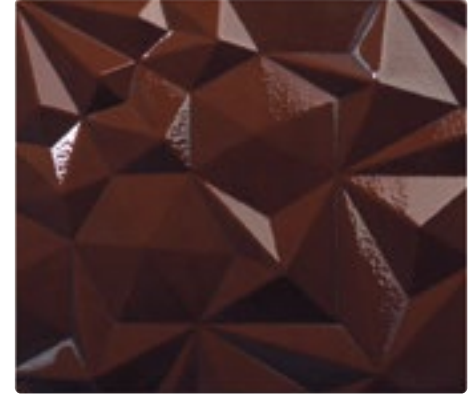

 **002880**
 30 Ends of yule log White choc "Origami" 8,5 x 7,5 cm







 **003989**
 30 Ends of yule log Dark choc "Origami" 8,5 x 7,5 cm





 **NEW 098336**
 60 Ends of yule log Dark choc "Spirale" 8,5 x 7,5 cm



 **NEW 098340**
 60 Ends of yule log Dark choc "Ondulation" 8,5 x 7,5 cm
 Free of colouring  Worldwide • Azo



 **NEW 098341**
 60 Ends of yule log Dark choc "Branchage" 8,5 x 7,5 cm



Discover our new concept!

Clever customization: sign your name or an event name:
these end-pieces feature a space for a plaque of your choice (ø 17mm)!

**The box is made up of 50% end-pieces with space for your design
and 50% without.**



088102

120 Small ends of yule log White choc
"Couronne hivernale" 4 cm - N/A: China,
Japan, Hong Kong



088103

120 Small ends of yule log Dark choc
"Vent d'hiver" 4 cm - N/A: USA, China,
Japan, UAE, Saudi Arabia, Qatar, Kuwait,
Bahrain, Oman, South Korea, Singapore



NEW 098330

56 Small ends of yule log Dark choc "Iris" 2 designs 6,1 x 4,8 cm

098331

4 Blisters "Emboutes de bûchettes Iris" 112 prints 6,1 x 4,8 cm 2 designs



088106

140 Small ends of yule log White choc
"Nuit de Noël" 3,9 x 3,95 cm - N/A: USA,
China, Japan, UAE, Saudi Arabia, Qatar, Kuwait,
Bahrain, Oman, South Korea, Singapore



088107

140 Small ends of yule log Dark choc
"Nuit étoilée" 3,9 x 3,95 cm - N/A: USA,
China, Japan, UAE, Saudi Arabia, Qatar, Kuwait,
Bahrain, Oman, South Korea, Singapore



088108

140 Small ends of yule log White choc
"Flocon" 3,9 x 3,95 cm - N/A: USA, China,
Japan, UAE, Saudi Arabia, Qatar, Kuwait,
Bahrain, Oman, South Korea, Singapore



088109

140 Small ends of yule log Dark choc
"Branchage" 3,9 x 3,95 cm - N/A: USA,
China, Japan, UAE, Saudi Arabia, Qatar, Kuwait,
Bahrain, Oman, South Korea, Singapore



088110

108 Small ends of yule log Dark choc
"Boule de Noël" 4 x 4 cm - N/A: USA,
China, Japan, UAE, Saudi Arabia, Qatar, Kuwait,
Bahrain, Oman, South Korea, Singapore



088111

108 Small ends of yule log Dark choc
"Volutes" 4 x 4 cm - N/A: USA, China, Japan,
UAE, Saudi Arabia, Qatar, Kuwait, Bahrain,
Oman, South Korea, Singapore



088112

108 Small ends of yule log Dark choc
"Arabesques" 4 x 4 cm - N/A: USA, China,
Japan, UAE, Saudi Arabia, Qatar, Kuwait,
Bahrain, Oman, South Korea, Singapore



088113

108 Small ends of yule log Dark choc
"Joyeuses Fêtes" 4 x 4 cm - N/A: USA,
China, Japan, UAE, Saudi Arabia, Qatar, Kuwait,
Bahrain, Oman, South Korea, Singapore

Please note the decorations are not shown in real size.



💡 | USE THIS KIT WITH THE “GOUTTIÈRE”
YULE LOG MOULD 070587 P. 107



070439 ● ● ●

6 Blisters “Santa Express” for 12 locomotives
N/A: USA, China, Japan, Qatar, South Korea, Singapore

ECLAIR CHOCOLATE TOPPINGS

Please note the references are not shown in real size.



CURVED ECLAIR

040079

24 Curved eclair Dark Choc "Pois bronze" 3 designs 13,2 x 3,2 cm - N/A: USA, China, Japan, UAE, Saudi Arabia, Qatar, Kuwait, Bahrain, Oman, South Korea, Singapore

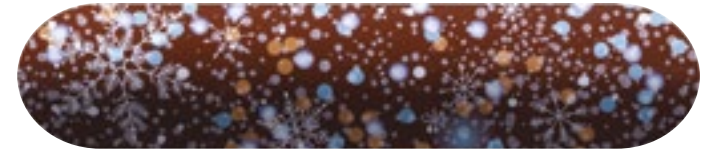

070079

24 Curved eclairs Dark choc "Cristaux" 13,2 x 3,2 cm • N/A: UAE, Saudi Arabia, Qatar, Kuwait, Bahrain, Oman



060496

60 Eclairs White choc "Père Noël" 13,2 x 3,2 cm - N/A: USA, China, Singapore

ECLAIR



040190

60 Eclairs Dark Choc "Chocolat" 13,2 x 3,2 cm - N/A: China, Singapore

TRANSFER SHEETS



TRANSFER SHEETS



070214 "Solstice" ●●●●●
17 Transfer sheets 40 x 25 cm •
N/A: UAE, Saudi Arabia, Qatar, Kuwait, Bahrain, Oman



087001 "Pluie de flocons" ●●●●●
17 Transfer sheets 40 x 25 cm - N/A: USA, China, Japan,
UAE, Saudi Arabia, Qatar, Kuwait, Bahrain, Oman, South
Korea, Singapore



070215 "Antalya" ●●●●●
17 Transfer sheets 40 x 25 cm •
N/A: UAE, Saudi Arabia, Qatar, Kuwait, Bahrain, Oman



088007 "Pins" ●●●●●
17 Transfer sheets 40 x 25 cm
N/A: USA, China, Japan, UAE, Saudi Arabia, Qatar,
Kuwait, Bahrain, Oman, South Korea, Singapore



088006 "Baies de houx" ●●●●●
17 Transfer sheets 40 x 25 cm
N/A: USA, China, Japan, UAE, Saudi Arabia, Qatar, Kuwait,
Bahrain, Oman, South Korea, Singapore



NEW 098252 "Flocon" ●●●●●
17 Transfer sheets 40 x 25 cm - N/A: USA, China,
Japan, UAE, Saudi Arabia, Qatar, Kuwait, Bahrain,
Oman, South Korea, Singapore

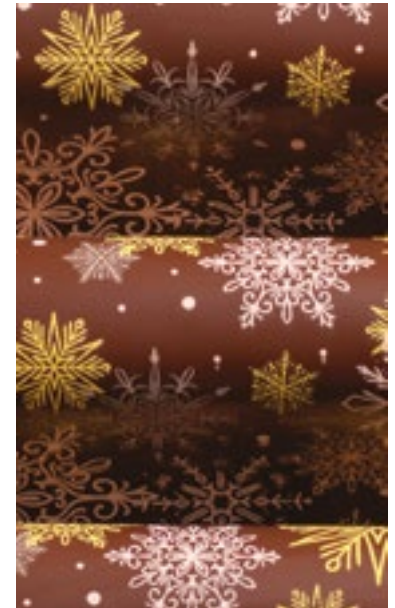

060100 "Froidure" ●●●●●
17 Transfer sheets 40 x 25 cm
N/A: USA, China, Singapore

There are a thousand and one uses for these transfer sheets. These patterns are available in colours not featured in this catalogue on orders of 125 sheets or more. Let us know what colour you fancy and we'll be delighted to whip up a special edition just for you...



SEE INSTRUCTIONS
ON OUR WEBSITE



TRANSFER SHEETS



060342 "Aladine" ● ● ● ● ●
17 Transfer sheets 40 x 25 cm
N/A: USA, China, Japan, UAE, Saudi Arabia, Qatar, Kuwait, Bahrain, Oman, South Korea, Singapore



060137 "Arabesques scintillantes" ● ● ● ● ●
17 Transfer sheets 40 x 25 cm - N/A: USA, China, Japan, UAE, Saudi Arabia, Qatar, Kuwait, Bahrain, Oman, South Korea, Singapore



🌐 **065221 "Joyeuses Fêtes"** ● ● ● ● ●
17 Transfer sheets 40 x 25 cm

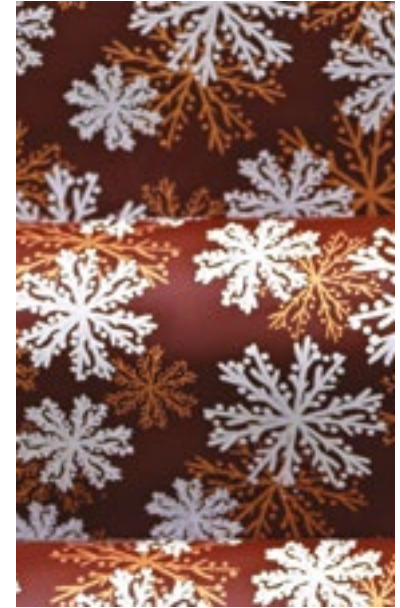

NEW 098253 "Hiver givré" ● ● ● ● ●
17 Transfer sheets 40 x 25 cm - N/A: USA, China, Japan, Qatar, South Korea, Singapore

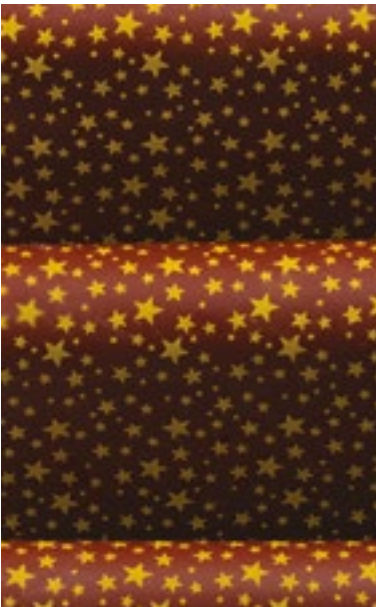

060143 "Constellation" ● ● ● ● ●
17 Transfer sheets 40 x 25 cm - N/A: China, Singapore



087050 "Feuilles de Houx" ● ● ● ● ●
17 Transfer sheets 40 x 25 cm - N/A: USA, China, Japan, South Korea, Hong Kong



070462 "Grain de folie" ● ● ● ● ●
17 Transfer sheets 40 x 25 cm ● N/A: UAE, Saudi Arabia, Qatar, Kuwait, Bahrain, Oman



065001 "24 Décembre" ● ● ● ● ●
17 Transfer sheets 40 x 25 cm
N/A: China, Japan, UAE, Saudi Arabia, Qatar, Kuwait, Bahrain, Oman, Hong Kong





CHOCOLATE KITS

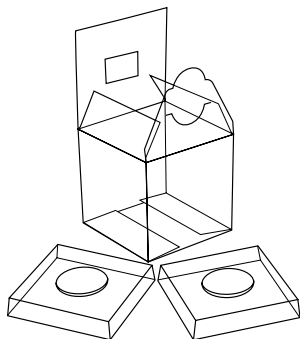

- 004433**
 12 Packing boxes for balls ø 7 cm
 12 plastic boxes + 24 supports
 Dimensions: 8,5 x 8,5 x 8,5 cm
 Dimensions supports: 8,5 x 8,5 x 1,5 cm

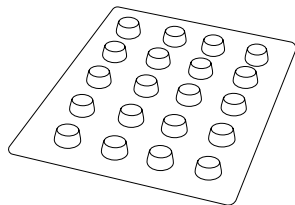

- 009885**
 3 Blisters "Attaches boules" so 60 prints

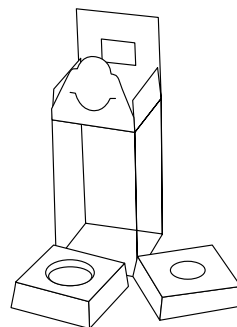

- 004431**
 12 Packing boxes for Matriochkas
 12 plastic boxes + 24 supports



Remember to order
 suitable packaging
 to highlight your
 chocolate products!



- 070017**
 12 Balls White choc "Arabesques" 3 designs ø 7 cm - Weight: ± 50 g • N/A: Canada, UAE, Saudi Arabia, Qatar,
 Kuwait, Bahrain, Oman



- 065243**
 12 Matriochkas White choc "Père Noël"
 H. 10 cm - Weight : ± 45 g - N/A: China,
 Hong Kong, Singapore



NEW 098325 ●

10 Moulds "A l'ancienne"

for 5 pieces 8,5 x 13 cm - Th. : ± 6 cm
Weight: ± 90 g - N/A: USA, China, Japan,
Qatar, South Korea, Hong Kong, Singapore

KITS



060596 ●●●●

20 Moulds reindeer "Jean-Rudolphe" for 10 pieces
9 x 15 cm - Weight: ± 105 g
N/A: USA, China, Japan, Qatar, South Korea, Singapore



088255 ●●●●

10 Moulds "Casse noisette"
for 5 pieces 7,95 x 13,5 cm - Weight: ± 100 g
N/A: USA, China, Japan, UAE, Saudi Arabia, Qatar, Kuwait,
Bahrain, Oman, South Korea, Singapore



070437 ●●●●

20 Moulds Santa "Dans ma hotte" for 10 pieces
8,7 x 15 cm - Weight: ± 80 g
N/A: USA, China, Japan, Qatar, South Korea, Singapore



065242 ●●●●

10 Moulds "Tête de Renne" for 5 pieces 11 x 11 cm
H. 7,6 cm - Weight: ± 90 g
N/A: China, Singapore, Japan



070438 ●●●●

20 Moulds "Sucre d'orge" for 10 pieces
8 x 17 cm - Weight: ± 80 g
N/A: China, Singapore



087169 ●●●●

16 Moulds "Sven" for 8 pieces
13 x 14,5 cm - Weight: ± 70 g
N/A: USA, China, Japan, UAE, Saudi Arabia, Qatar, Kuwait,
Bahrain, Oman, South Korea, Singapore



🌿 045563
20 Moulds "Renne" for 10 pieces
9 x 15 cm - Weight: ± 105 g



060597 ● ● ● ● ●
10 Moulds "Demi-bouteille de champagne"
for 5 pieces 5 x 17,5 cm - Weight: ± 36 g
N/A: USA, China, Japan, UAE, Saudi Arabia, Qatar,
Kuwait, Bahrain, Oman, South Korea, Singapore

CHRISTOPHE
Michalak





🌿 060212
9 Moulds "Mon Beau Sapin" for 3 pieces
ø 14 cm, ø 11 cm, ø 8 cm, ø 6 cm, ø 4 cm
Weight: ± 100 g





🌿 070429
10 Moulds "Sapin Poché" for 5 pieces
11,6 x 15 cm - Th. 11,8 cm - Weight: ± 100 g



🌿 088238
8 Moulds "Sapin Vrille" for 4 pieces
9,6 x 15 cm - Th. 9,5 cm
Weight: ± 70 g

 **NEW** 098365
 6 Moulds "Pilotes de Noël"
for 6 pieces 2 designs 3,9 x 5,1 cm
and 6,8 x 6,85 cm - Th. ± 4 cm
and 4,65 cm - Weight: ± 15 g - 20 g

 **NEW** 098364
 18 Moulds "Bolide" for 6 pieces
20,4 x 9,2 cm - Th. ± 7 cm
Weight: ± 190 g

*Studio's
favorite*

 **NEW** 098224

24 Moulds "Boules graphiques"
for 12 pieces 3 designs 7,2 x 8,4 cm
Weight: ± 100 g

QUENTIN

Bailly



CUSTOMIZE THESE BALLS WITH YOUR
PERSONALIZED CHOCOLATE PIECE
(Ø 1.7 CM) IN THE DESIGNATED SLOT.

KITS



🌿 010208
8 Moulds "Père Noël bonnet"
for 4 pieces 6 x 5,8 cm
Weight: ± 45 g

These moulds are neutral.



🌿 074318
15 Moulds "Boules de Noël"
for 15 pieces 5 designs 5 x 5,8 cm
Th. 2,5 cm - Weight: ± 20 g



🌿 009842
6 Moulds "Traineau" for 2 pieces
21 x 10,5 cm - H. 13 cm Weight: ± 300 g
(see instructions on our website)



🌿 060209
10 Moulds "Ours frileux"
for 5 pieces - 9 x 15 cm - Th. 6 cm
Weight: ± 90 g



🌿 074316
12 Moulds "Père Noël Slave"
for 6 pieces - 12,7 x 13 cm - Th. 7,5 cm
Weight: ± 120 g

This mould is neutral.



🌿 074311
12 Moulds "Casse Noisette"
for 6 pieces - 6 x 17 cm - Th. 5,2 cm
Weight: ± 70 g

 **NEW** 098363

8 Moulds "Traineau Baroque"
for 4 pieces 13 x 10,8 cm
Th. ± 7 cm - Weight: ± 80 g





🌱 087065

12 Moulds "Tablette Couronne de l'Avent" for 12 pieces
18 x 19 cm - H. 1,5 cm - Weight: ± 180 g



🌱 088247

12 Moulds "Tablette P'tit Biscuit" for 12 pieces
11,6 x 14 cm - H. 1,8 cm - Weight: ± 100 g



🌱 074314

12 Moulds "Tablette horloge" for 12 pieces
ø 15,5 cm - Th. 1 cm - Weight: ± 130 g



🌱 045564

12 Moulds "Avent" for 12 pieces 19,6 x 16,5 cm
Th. 0,7 cm - Weight: ± 220 g



BLISTERS PUZZLE



SEE INSTRUCTIONS
ON OUR WEBSITE



NEW 088153 ●●●●

10 Blisters puzzles "Les jouets" 19 x 13 cm - Weight: ± 100 g
N/A: USA, China, Japan, South Korea, Singapore



074249 ●●●●

10 Blisters puzzle "Family" 19 x 13 cm - Weight: ± 100 g - N/A: China, Japan, UAE, Saudi Arabia, Qatar, Kuwait, Bahrain, Oman



NEW 098245 ●●●●

10 Blisters puzzles "Ça glisse" 19 x 13 cm - Weight: ± 100 g
N/A: China, Japan, UAE, Saudi Arabia, Qatar, Kuwait, Bahrain, Oman



087171 ●●●●

10 Blisters puzzles "Rock'N'Noël" 19 x 13 cm - Weight: ± 100 g
N/A: USA, China, Japan, UAE, Saudi Arabia, Qatar, Kuwait, Bahrain, Oman, South Korea, Singapore



087172 ●●●●

10 Blisters puzzles "La fine équipe" 19 x 13 cm - Weight: ± 100 g
N/A: USA, China, Japan, UAE, Saudi Arabia, Qatar, Kuwait, Bahrain, Oman, South Korea, Singapore



088066 ●●●●

10 Blisters puzzles "Bande de casse-noisette" 19 x 13 cm - Weight: ± 100 g
N/A: China, Japan, UAE, Saudi Arabia, Qatar, Kuwait, Bahrain, Oman, Singapore

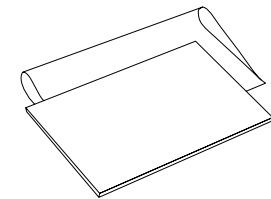

004428
10 Packing boxes for puzzles
(support cardbox and bags)

NEW 098327 ●●●

9 Blisters lollipops "Nez rouge" and sticks
for 45 prints 4,5 x 7,1 cm
Weight: ± 20 g - N/A: China, Japan



KITS



070018 ●●●●●
9 Blisters lollipops "Noël" and sticks for 45 prints 5 designs ø 5,4 cm •
N/A: UAE, Saudi Arabia, Qatar, Kuwait, Bahrain, Oman

NEW 098324 ●●●●●
9 Blisters lollipops "Chaussettes de Noël" and sticks for 45 prints 3 designs
± 4,4 x 7,5 cm - Weight: ± 15 g - N/A: China, Japan, UAE, Saudi Arabia, Qatar, Kuwait,
Bahrain, Oman, Hong Kong, Singapore

061247 ●●●●●
9 Blisters lollipops "Candy" and sticks for 27 prints
ø 7,4 cm - N/A: China, Japan

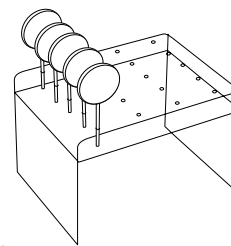

074290 ●●●●●
9 Blisters lollipops "Boule à neige" and sticks for 45 prints 3 designs 5 x 6 cm
Weight: ± 15 g - N/A: USA, China, Japan, UAE, Saudi Arabia, Qatar, Kuwait, Bahrain, Oman,
South Korea, Singapore

087051 ●●●●●
9 Blisters lollipops "Pains d'épices" and sticks for 45 prints 5 designs H. 6 cm
Weight: ± 15 g - N/A: China, Japan, Hong Kong

004478
500 Sticks Lollipop birch
9 x 0,38 cm



004560
Display for lollipops for 20 pieces
25 x 18 cm - H. 16,5 cm

070186 ●●●●●
9 Blisters lollipops "Père Noël" and sticks for 45 prints 5 designs ø 5,4 cm •
N/A: UAE, Saudi Arabia, Qatar, Kuwait, Bahrain, Oman

074202 ●●●●●
9 Blisters lollipops "Père Noël" and sticks for 45 prints 3 designs
H. ± 7 cm - Weight: ± 15 g - N/A: USA, China, Japan, UAE, Saudi Arabia,
Qatar, Kuwait, Bahrain, Oman, South Korea, Singapore

002138
50 Bags for Lollipops



Free of colouring • Worldwide • Azo • Usable chocolates



TRANSFER SHEETS & MOULDS FOR MUGS

Mugs dimensions: ø 8 cm - H. 10 cm - Weight: ± 75 g

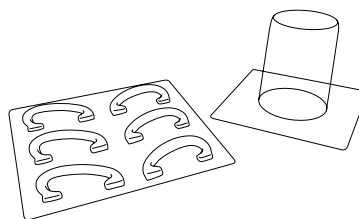
**087003** ●●●10 Transfer sheets "Carrousel" for mugs 25,3 x 11 cm
N/A: USA, China, Japan, UAE, Saudi Arabia, Qatar, Kuwait, Bahrain, Oman, South Korea, Singapore**088068** ●●●10 Transfer sheets "Les jouets" for mugs 25,3 x 11 cm
N/A: China, Japan, Hong Kong, Singapore**025191**4 Moulds "Mugs et anses" for 3 pieces
ø 8 cm - H. 10 cm - Weight: ± 75 gSEE INSTRUCTIONS
ON OUR WEBSITE

TRANSFER SHEETS & MOULDS FOR CONES

Cone dimensions: ø 11 cm - H. 13 cm - Weight: ± 55 g

**070326** ●●●

10 Transfer sheets "Père Noël" for cones 25,5 x 13,6 cm 2 designs - N/A: USA, China, Singapore

**088071** ●●●

10 Transfer sheets "Les oursins" for cones 25,5 x 13,6 cm 2 designs - N/A: USA, China, Japan, UAE, Saudi Arabia, Qatar, Kuwait, Bahrain, Oman, South Korea, Singapore

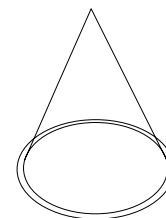
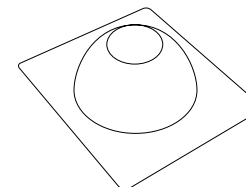
**009884**5 Moulds "Grands cônes"
ø 11 cm - H. 13 cm
Weight: ± 55 g**070421**

10 Moulds "Dessous de bonbonnière" ø 9 cm - Th. 4 cm



TRANSFER SHEETS & MOULDS FOR SMARTPHONES

Smartphones dimensions: 6,1 x 11,6 cm - Weight: ± 47 g



087004 ● ● ● ●
12 Transfer sheets for smartphones
"Pingu" - N/A: USA, China, Japan, UAE,
Saudi Arabia, Qatar, Kuwait, Bahrain, Oman,
South Korea, Singapore



088069 ● ● ● ●
12 Transfer sheets for smartphones
"P'tit biscuit" - N/A: China, Japan,
Singapore



NEW 098219 ● ● ● ●
12 Transfer sheets for smartphones
"Santa calling" - N/A: China, Japan,
Singapore



SEE INSTRUCTIONS
(SAME AS CARDS)
ON OUR WEBSITE

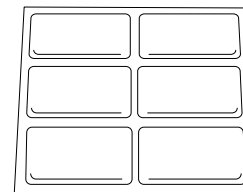

045558
2 Moulds smartphones for 12 pieces
6,5 x 12 cm - Th. 0,6 cm - Weight: ± 47 g

TRANSFER SHEETS & MOULDS FOR CARDS

Cards dimensions: 21 x 10,5 cm - H. 0,5 cm - Weight: ± 110 g

**NEW** 098231 ●●●

30 Transfer sheets "Ho Ho Ho" for cards and bags - N/A: USA, China, Japan



088072 ●●●

30 Transfer sheets "Pingouins joyeux" for cards and bags - N/A: USA, China, Japan, UAE, Saudi Arabia, Qatar, Kuwait, Bahrain, Oman, South Korea, Hong Kong

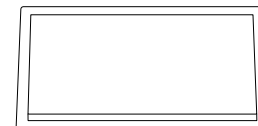

010144

10 Moulds "Cartes"
Dimensions: 21 x 10,5 - H. 0,5 cm
Weight: ± 110 g

TRANSFER SHEETS & MOULDS FOR SQUARE CARDS

Square cards dimensions: 12 x 12 cm - H. 0,5 cm - Weight: ± 65 g

**NEW** 087178 ●●●

24 Transfer sheets "Le duo" for square cards and bags - N/A: USA, China, Japan, UAE, Saudi Arabia, Qatar, Kuwait, Bahrain, Oman, South Korea, Singapore

**NEW** 098239 ●●●

24 Transfer sheets "Gang de pingouins" for square cards and bags - N/A: USA, China, Japan



088073 ●●●

24 Transfer sheets "Au pied du sapin" for square cards and bags - N/A: China, Japan, UAE, Saudi Arabia, Qatar, Kuwait, Bahrain, Oman, Singapore

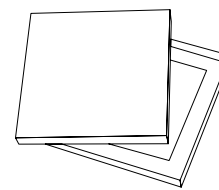

004429

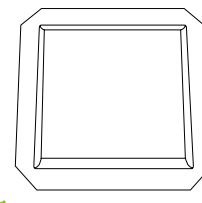
12 Packing boxes for square cards
12 Boxes, 12 blisters, 48 paddings
and 12 protective films

009961

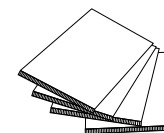
12 Moulds "Cartes carrées"
Dimensions: 12 x 12 cm
H. 0,5 cm - Weight: ± 65 g

004432

100 bags for square cards



CLAIRE
Heitzler

 **NEW** 098316

30 Entremets moulds "Sapin" for 60 pieces

Top: 7,4 x 7,1 cm - H. 3,1 cm

Moulds with support jams

Bottom: 7,9 x 7,55 cm - H. 0,5 cm

Moulds without support jams

INDIVIDUAL ENTREMETS MOULDS

Reusable and **freezable**, these moulds allow you to remove your desserts with ease.

We have designed a "**support jamb**" around most of our reusable moulds which you can for hot water into in order to **remove your desserts more easily**.

CLAIRE
Heitzler



🌿 087015

22 Entremets moulds "Sapin" for 36 pieces
Top: 8,75 x 11,2 cm - H. 2,4 cm
Moulds with support jams
Bottom: 8,97 x 11,4 cm - H. 0,5 cm
Moulds without support jams

JEAN-MICHEL
Perruchon



🌿 070525

30 Entremets moulds
"Bonnet de Père Noël" for 120 pieces
ø 7 cm - H. 5,2 cm - Moulds with support jams



🌿 074233

30 Entremets moulds "Étoile"
for 180 pieces 8 x 7,6 cm - H. 4 cm
Moulds with support jams



🌿 070545

30 Entremets moulds
"Champagne" for 90 pieces
5,8 x 13,5 cm - H. 3 cm
Moulds with support jams



🌿 070575

10 Entremets moulds
"Bûchette rondin" 54 x 3,8 cm - H. 3,8 cm
Moulds with support jams



🌿 045841

10 Entremets moulds
"Mini-bûchette" 54 x 3,8 cm - H. 3,8 cm

🌿 048002

100 Rhodoïde sheets neutral 52,7 x 9,5 cm
to insert into the mould 045841

088248

30 Entremets Moulds "Ourson"
for 30 pieces 13,1 x 22,3 cm - H. 6,65 cm
Moulds with support jambs



CHRISTOPHE
Michalak

ENTREMETS MOULDS

VINCENT

Guerlais



🌱 070528

30 Entremets moulds "Igloo"
for 30 pieces 19,5 x 21 cm - H. 9 cm
Moulds with support jams

JEAN-MICHEL

Perruchon



🌱 070524

30 Entremets moulds "Bonnet de Noël"
for 30 pieces ø 18 cm - H. 15 cm

CLAIRE

Heitzler



🌱 065313

10 Entremets moulds
"Sphère" to clip for
5 pieces ø 12 cm - H. 10 cm

🌱 065122

2 Blisters "Attaches-boules"
80 prints
ø 3 cm - H. 0,8 cm



🌱 087016

45 Entremets moulds "Sapin" for 30 pieces
Top: 17,7 x 22,6 cm - H. 4,5 cm - Moulds with support jams
Bottom: 18,2 x 23,2 cm - H. 0,5 cm
Moulds without support jams

CLAIRE

Heitzler



🌱 088191

60 Entremets moulds "Couronne" for 30 pieces
Top: ø 21,9 cm - H. 2,3 cm
Bottom: ø 22,3 cm - H. 0,8 cm

 **NEW** 088193

30 Yule log moulds "Plissée"
for 30 pieces 23,2 x 7,3 cm - H. 7,6 cm
Moulds with support jambs

ÉTIENNE
Leroy

YULE LOG MOULDS



🌿 070539

30 Moulds Top of yule log "Rondin"
for 30 pieces 23,6 x 6,6 cm - H. 3,5 cm
Moulds with support jams

🌿 070538

30 Moulds "Dessous de bûches"
for 30 pieces 24 x 7 cm - H. 4 cm



🌿 070532

30 Moulds Top of yule log "Marquise"
for 30 pieces 23,6 x 6,6 cm - H. 2 cm
Moulds with support jams

🌿 070538

30 Moulds "Dessous de bûches"
for 30 pieces 24 x 7 cm - H. 4 cm



🌿 070533

30 Moulds Top of yule log "Duchesse"
for 30 pieces 23,6 x 6,6 cm - H. 3 cm
Moulds with support jams

🌿 070538

30 Moulds "Dessous de bûches"
for 30 pieces 24 x 7 cm - H. 4 cm



🌿 070540

30 Moulds Top of yule log "Éminence"
for 30 pieces 23,6 x 6,6 cm - H. 2,5 cm
Moulds with support jams

🌿 070538

30 Moulds "Dessous de bûches"
for 30 pieces 24 x 7 cm - H. 4 cm

YULE LOG MOULDS



NEW 098370

10 Yule log moulds "Vague"
54 x 8 cm - H. 6,5 cm
Moulds with support jambs

ÉTIENNE

Leroy



NEW 088194

10 Yule log moulds "Pyramide"
54 x 9 cm - H. 7 cm
Moulds with support jambs



074237

30 Moulds entremets
"Lingot 24 cm"
for 30 pieces
24 x 8 cm - H. 5,5 cm
Moulds with support jambs

074238

30 Moulds entremets
"Lingot 16 cm"
for 30 pieces
16 x 8 cm - H. 5,5 cm
Moulds with support jambs



065147

10 Yule log moulds "Ooreka" 54 x 8 cm
H. 6,5 cm - Moulds with support jambs



074240

30 Yule log moulds "Arrondie"
for 30 pieces 20 x 8 cm - H. 7 cm
Moulds with support jambs



074244

10 Yule log moulds "Rectangle arrondi"
54 x 8 cm - H. 6,5 cm
Moulds with support jambs

YULE LOG MOULDS



🌿 000366
4 Yule log moulds "Boules"
51 x 8 cm - H. 6,5 cm
Moulds with support jambs



🌿 070574
10 Yule log moulds "Fond plat"
54 x 8 cm - H. 6,5 cm
Moulds with support jambs



🌿 060232
10 Yule log moulds "Montagne"
54 x 7 cm - H. 8 cm
Moulds with support jambs



🌿 060233
10 Yule log moulds "Ondes"
54 x 8 cm - H. 6,5 cm
Moulds with support jambs

ÉTIENNE

Leroy



🌿 087068
10 Yule log moulds "Dessus plat"
54 x 8 cm - H. 6,5 cm
Moulds with support jambs



🌿 070573
10 Yule log moulds "Facettes"
54 x 8 cm - H. 6,5 cm
Moulds with support jambs

YULE LOG MOULDS



🌿 070544
30 Yule log moulds "Nuage"
for 30 pieces 20 x 11 cm - H. 7 cm
Moulds with support jambs

YANN
Brys



🌿 070571
30 Yule log moulds "Mont blanc" for
15 pieces - Top: 22,8 x 6 cm - H. 2,8 cm
Moulds with support jambs
Bottom: 25 x 8 cm - H. 4,5 cm



🌿 070519
30 Yule log moulds "Trésor"
for 30 pieces 20 x 8 cm - H. 7,2 cm
Moulds with support jambs

VINCENT
Guerlais



🌿 070526
30 Yule log moulds "Champagne"
for 30 pieces 25 x 9 cm - H. 5,6 cm
Moulds with support jambs



🌿 074239
30 Classic yule log moulds "6 parts"
for 30 pieces 18 x 8 cm - H. 6,5 cm
Moulds with support jambs

CHRISTOPHE
Michalak



🌿 009992
1 Yule log mould "Tube"
50 cm ø 6,4 cm and 2 covers
🌿 005019
100 Rhodoïde sheets neutral 50 x 21 cm



🍷 070587

10 Yule log moulds "Gouttière"
54 x 8 cm - H. 6,5 cm

🍷 048001

100 Rhodoïde sheets neutral
52,7 x 17,7 cm to insert
into the mould 070587

🍷 060234

10 Moulds "Petite bûche gouttière"
54 x 5,7 cm - H. 5 cm

🍷 060235

100 Rhodoïde sheets neutral 52,7 x 12,7 cm
to insert into the mould 060234

🍷 045841

10 Moulds "Mini-bûchette" 54 x 3,8 cm

🍷 048002

100 Rhodoïde sheets neutral 52,7 x 9,5 cm
to insert into the mould 045841

eL
ETIENNE LEROY

060156

10 Structure sheets "Petit Matelassé"
for yule log 52,7 x 17,7 cm



DOUCEURS
QUI FONT
SOURIRE.

(060156 - Structure sheets
"Petit Matelassé" for yule log + 070587
Yule log moulds "Gouttière" + 088207
Mini freeze-dried petals "Rose pâle")

STRUCTURE SHEETS FOR YULE LOG

These structure sheets have been specially created to be used with our yule log moulds "Gouttière" (070587 P. 107).



SEE INSTRUCTIONS
ON OUR WEBSITE



ANTHONY
Terrone



🌱 060154

10 Structure sheets "Ananas" for yule log
52,7 x 17,7 cm



🌱 065066

10 Structure sheets "Envol" for yule log
52,7 x 17,7 cm



🌱 065067

10 Structure sheets "Écorce" for yule log
52,7 x 17,7 cm



🌱 060152

10 Structure sheets "Déstructuré" for yule log
52,7 x 17,7 cm

JÉRÔME
Chausse



🌱 **NEW** 088291

10 Structure sheets "Étoiles et ronds"
for yule log 52,7 x 17,7 cm



🌱 060153

10 Structure sheets "Mouvance" for yule log
52,7 x 17,7 cm



PH PASCAL HAINIGUE

DECORATIONS



061016
135 Hearts White choc "Love" 3 cm
N/A: China, Singapore



061394
165 Hearts Compound 2 x 1,7 cm
N/A: China, Japan



061275
266 Mini Hearts White choc 4 designs 1,3 x 1,3 cm
N/A: USA, China, Japan, UAE, Saudi Arabia, Qatar, Kuwait, Bahrain, Oman, Hong Kong

VALENTINE'S DAY



087052
135 Hearts White choc "Kelsch" 5 designs 3 cm - N/A: China, Japan



NEW 098291
108 Decorations compound
"J'aime" 2,4 x 2,5 cm - N/A: China, Japan



008630
Hearts Dark choc shiny bronze
1,4 x 1,38 cm - 200 g - N/A: USA, China, Japan, UAE, Saudi Arabia, Qatar, Kuwait, Bahrain, Oman, South Korea, Singapore



061274
40 Hearts White Choc "Love" 4,8 x 4,5 cm
N/A: China, Japan



087128
80 Decorations White Choc "Graffiti" 4,7 x 4,3 cm
N/A: USA, China, Japan, South Korea



074278
140 Wax seals "Cœur" compound 2 designs ø 3,5 cm - N/A: Hong Kong



087127
50 Envelopes White Choc "I love You" 4,85 x 5,8 cm
N/A: China, Japan, UAE, Saudi Arabia, Qatar, Kuwait, Bahrain



087048
66 Rectangles White choc "Be my Valentine" 2 designs 4 x 2,9 cm
N/A: China, Japan



087006
100 Stamps White choc "Love"
3,3 x 4,5 cm - N/A: China, Japan, UAE, Saudi Arabia, Qatar, Kuwait, Bahrain

DECORATIONS



NEW 098206
60 Rectangles White choc "Love"
4 x 2,9 cm - N/A: USA, China, Japan



088076
140 Rectangles White Choc "Declaration"
4 x 2 cm - N/A: China, Japan



088074
110 Rectangles White Choc "Love" 7 x 2 cm - N/A: China, Japan, Hong Kong

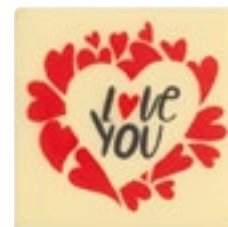

088075
88 Squares White Choc "Love you"
3 cm - N/A: China, Japan, Hong Kong



088077
300 Hearts White Choc "Mots d'amour" 6 designs
2 x 1,7 cm - N/A: China, Japan, Hong Kong



NEW 098204
132 Rectangles White choc
"Love you" 2,9 x 4 cm - N/A:
China, Japan



061277
65 Lips Compound 2 designs 4,3 x 2,5 cm
N/A: China, Japan



061276
190 Mini lips Compound 2 designs
2 x 1,45 cm - N/A: China, Japan, UAE, Saudi
Arabia, Qatar, Kuwait, Bahrain, Oman



NEW 098155
300 Hearts White choc "Happy" 6 designs 2 x 1,7 cm - N/A: USA,
China, Japan, South Korea, Hong Kong



NEW 098205
126 Hearts White choc "Lingerie" 2 designs 3,6 x 3,3 cm - N/A: China, Japan



087101
100 Hearts White choc embossed "Je t'aime" 5,85 x 5,4 cm



074335
Sugar hearts shiny ruby 0,6 cm - 200 g
N/A: USA, Canada, China, Japan, South Korea, Taiwan, Singapore



061332 "Amour"
17 Transfer sheets 40 x 25 cm - N/A: China, Japan

DECORATIONS

FLORENT
Margaillan



025192
2 Moulds "Tablette Cœurs" for 8 pieces
15,5 x 6,2 cm - Weight: ± 70 g



NEW 098248 ● ● ●
15 Transfer sheets "Filtre d'amour" for flasks 3,4 x 2,8 cm - N/A: USA, China, Japan, UAE, Saudi Arabia, Qatar, Kuwait, Bahrain, Oman, South Korea, Singapore

NEW 088237
10 Moulds "Fiole" for 5 pieces
14 x 3,4 cm - Th.: 6,8 cm
Weight: ± 65 g



NEW 098227
10 Moulds half-bottle "Cuvée amour" for 5 pieces
5 x 17,5 cm - Weight: ± 36 g - N/A: USA, China, Japan, UAE, Saudi Arabia, Qatar, Kuwait, Bahrain, Oman, South Korea, Singapore



087164 ● ● ●
4 Moulds "Que du love" for 8 pieces 10 x 10 cm
H. 1,5 cm - Weight: ± 60 g - N/A: USA, China, Japan, Qatar, South Korea, Singapore



087180 ● ● ●
10 Transfer sheets "Je t'aime" for mugs
25,3 x 11 cm - N/A: USA, China, Japan, UAE, Saudi Arabia, Qatar, Kuwait, Bahrain, Oman, South Korea, Singapore

025191
4 Moulds "Mugs et anses" for 3 pieces ø 8 cm - H. 10 cm
Weight: ± 75 g

MOTHER & FATHER'S DAYS



NEW 098287

90 Decorations Dark choc "Mom" 5,1 x 1,6 cm
N/A: China, Japan, UAE, Saudi Arabia, Qatar, Kuwait, Bahrain, Oman



NEW 098186

132 Rectangles Compound
"Mom" 2,9 x 4 cm
N/A: China, Japan



087022

120 Hearts White choc "Happy Mother's day"
5 x 4,7 cm - N/A: China, Japan



074252

100 Hearts White choc "Happy Mother's day" 5,8 x 5,4 cm
N/A: China, Japan



088078

150 Whiskers Choc BC "Happy Father's day"
4,8 x 1,5 cm



NEW 098179

132 Rectangles White choc "Love U Mom" 2 designs 2,9 x 4 cm
N/A: China, Japan



088080

63 Wax seals "Happy Mother's day"
Compound ø 3,5 cm - N/A: China, Japan, Hong Kong



088079

63 Wax seals "Happy Father's day"
Compound ø 3,5 cm



070110

100 Diamonds White choc "Super papa" 4 x 3,5 cm • N/A: UAE, Saudi Arabia, Qatar, Kuwait, Bahrain, Oman



070474

120 Squares White choc "I Love Dad"
2 designs 3,5 cm • N/A: UAE, Saudi Arabia, Qatar, Kuwait, Bahrain, Oman



070473

120 Squares White choc "I Love Mum" 2 designs 3,5 cm • N/A: UAE, Saudi Arabia, Qatar, Kuwait, Bahrain, Oman



070465

120 Squares White choc "Mom"
4 cm • N/A: UAE, Saudi Arabia, Qatar, Kuwait, Bahrain, Oman



087054



120 Squares White choc "Mother's Day" 2 Designs 3,5 cm - N/A: China, Japan, Singapore



NEW 098285

96 Decorations White choc
"Best mom" 4 x 4,5 cm - N/A: China, Japan



  **NEW** 098407 ●●●●
12 Moulds "Moustache" for
12 pieces 19 x 6 cm - H. 2 cm

DIY

ENTREMETS MOULDS

FRÉDÉRIC

Cassel



🌿 070516

30 Entremets moulds "Cœur matelassé"
for 30 pieces 14,5 x 14,5 cm - H. 3,5 cm
Moulds with support jamba

🌿 **NEW** 098382

30 Entremets moulds
"Cœur spirale" for 30 pieces
17,3 x 17,8 cm - H. 5,5 cm
Moulds with support jamba

🌿 **NEW** 098383

30 Entremets moulds
"Cœur spirale 2 personnes"
for 60 pieces
11,16 x 11,5 cm - H. 3,7 cm
Moulds with support jamba

JEAN-PIERRE

Rodrigues



🌿 074070

30 Entremets moulds "Cœur diamant"
for 30 pieces 14,5 x 14,5 cm - H. 4 cm
Moulds with support jamba

ARNAUD

Lahrer



🌿 074069

30 Entremets moulds "Bouche for 2"
for 60 pieces 14,3 x 8,3 cm - H. 4 cm
Moulds with support jamba

🌿 074067

30 Entremets moulds "Bouche"
for 30 pieces 20 x 12 cm - H. 5 cm
Moulds with support jamba

ÉTIENNE

Leroy



🌿 087017

30 Entremets moulds "Cœur" for 60 pieces
11,2 x 11,8 cm - H. 3,8 cm
Moulds with support jamba

ÉTIENNE

Leroy



🌿 074066

30 Entremets moulds "Cœur drapé"
for 30 pieces 15,1 x 13,3 cm - H. 6,4 cm
Moulds with support jamba

ENTREMETS MOULDS



🌿 070515

30 Individual Entremets moulds "Cœur spirale"
for 120 pieces 8,4 x 8 cm - H. 3,3 cm
Moulds with support jamba

PHILIPPE

Rigollot



🌿 070548

30 Individual Entremets moulds
"Pomme" for 60 pieces
Top ø 7,4 cm - H. 2,6 cm
Moulds with support jamba
Bottom ø 7,4 cm - H. 3,7 cm
Moulds with support jamba



🌿 088192

30 Entremets moulds "Cœur lisse"
for 60 pieces 11 x 11 cm - H. 3,5 cm
Moulds with support jamba

ÉTIENNE

Leroy



🌿 074063

30 Individual Entremets moulds "Cœur drapé"
for 120 pieces 8,5 x 7,5 cm - H. 3,8 cm
Moulds with support jamba



🌿 074061

30 Individual Entremets moulds "Bouche"
for 180 pieces 9,5 x 5,6 cm - H. 3,5 cm
Moulds with support jamba



🌿 074060

30 Individual Entremets moulds "Petite tarte
rose" for 120 pieces ø 7,4 cm - H. 2 cm

🌿 070536

30 Individual Entremets moulds "Palet"
for 150 pieces ø 8 cm - H. 1,7 cm
Moulds with support jamba



DECORATIONS

ASIAN COLLECTION



070250
88 Squares Compound "Signe Chinois"
3 cm • N/A: UAE, Saudi Arabia, Qatar, Kuwait,
Bahrain, Oman



070278
176 Rounds Compound "Symbole"
ø 3 cm • N/A: UAE, Saudi Arabia,
Qatar, Kuwait, Bahrain, Oman



087035
140 Chinese coins Compound
ø 3,2 cm - N/A: China, Japan, Hong
Kong



NEW 098319
108 Decorations White choc "Mooncake"
3 designs ø 4 cm - N/A: UAE, Saudi Arabia,
Qatar, Kuwait, Bahrain, Oman



087045
72 Mini-cats White choc
"Maneki" 2,4 x 3,35 cm
N/A: China, Japan, Hong Kong



070341
210 Mini-lanterns White choc "Fête de la lumière" •
3 designs - N/A: Canada, China, UAE, Saudi Arabia, Qatar,
Kuwait, Bahrain, Oman, South Korea



070303 "Sérénité" ●●●●●
17 Transfer sheets 40 x 25 cm - N/A: UAE, Saudi Arabia, Qatar, Kuwait, Bahrain,
Oman



088018 "Wagara" ●●●●●
17 Transfer sheets 40 x 25 cm - N/A: USA, China, Japan, UAE, Saudi Arabia,
Qatar, Kuwait, Bahrain, Oman, South Korea, Hong Kong, Singapore



070364
192 Peanuts Choc BC 4 x 1,75 cm



087049
96 Banners White choc "Nouvel an" 6 x 2,7 cm - N/A: China,
Japan, Hong Kong



070384
176 Cherry blossoms White choc "Sakura" 2 designs • N/A: China,
UAE, Saudi Arabia, Qatar, Kuwait, Bahrain, Oman

070363
176 Cherry blossoms Compound "Rose" 3 cm • N/A: China, UAE, Saudi
Arabia, Qatar, Kuwait, Bahrain, Oman

Free of colouring Worldwide • Azo



088134
150 Cats White choc "Kawaii" 3 designs 2,7 x 3,1 cm - N/A:
UAE, Saudi Arabia, Qatar, Kuwait, Bahrain, Oman

(098151 - Eggs White choc "Inca"
+ 070558 - Tearable entremets
mould "Rond plat ø 18 cm" + 070567
Tearable entremets mould
"Dessus de tarte ø 15 cm")



HAPPY EASTER

**003779**

288 Eggs Dark choc "Scintillant" 6 designs - 2,7 x 4 cm
 N/A: USA, China, Japan, UAE, Saudi Arabia, Qatar, Kuwait, Bahrain, Oman, South Korea, Singapore

087023

288 Eggs Dark choc "Kermesse" 3 designs - 2,7 x 4 cm
 N/A: USA, China, Japan, UAE, Saudi Arabia, Qatar, Kuwait, Bahrain, Oman, South Korea, Singapore

061064

288 Eggs Dark choc "Joyaux" 3 designs - 2,7 x 4 cm
 N/A: USA, China, Japan, UAE, Saudi Arabia, Qatar, Kuwait, Bahrain, Oman, South Korea, Singapore

019168

63 Eggs White choc crystallized bronze
 2,3 X 3,4 cm - N/A: USA, China, Japan, Qatar, South Korea, Singapore

**088083**

288 Eggs Milk choc "Paisley" 3 designs - 2,7 x 4 cm - N/A: USA, China, Japan, UAE, Saudi Arabia, Qatar, Kuwait, Bahrain, Oman, South Korea, Singapore

**NEW 098151**

288 Eggs White choc "Inca" 4 designs - 2,7 x 4 cm

070029

288 Eggs White choc "Nuances" 3 designs - 2,7 x 4 cm •
 N/A: UAE, Saudi Arabia, Qatar, Kuwait, Bahrain, Oman

**088082**

288 Eggs White choc "Woodstock" 3 designs
 2,7 x 4 cm - N/A: China, Japan, Hong Kong

088081

288 Eggs White choc "Marguerite" 3 designs - 2,7 x 4 cm -
 N/A: China, Japan, Hong Kong

NEW 098152

288 Eggs White choc "Floraison" 2,7 x 4 cm - N/A: China, Japan, Hong Kong

074058

288 Eggs White choc "Pop" 4 designs 2,7 x 4 cm - N/A: USA, China, Japan, Hong Kong

DECORATIONS

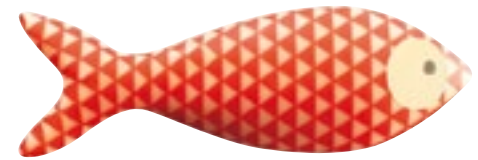
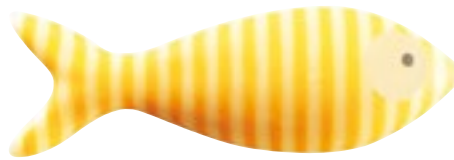

070089

112 Sardines White choc "En bande" 3 designs 6 x 2 cm •
N/A: UAE, Saudi Arabia, Qatar, Kuwait, Bahrain, Oman



070087

252 Mini-rabbits White choc 6 designs 1,9 x 2,5 cm • N/A: China, UAE, Saudi Arabia, Qatar, Kuwait, Bahrain, Oman



NEW 098167

110 Rectangles White Choc "Lapins de Pâques" 7 x 2 cm
N/A: USA, China, Japan, Hong Kong

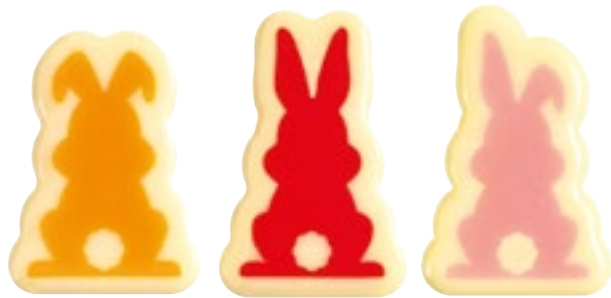

088127

144 Rabbits White choc "Le trio" 3 designs - N/A: China, Japan, UAE, Saudi Arabia, Qatar, Kuwait, Bahrain, Oman, Hong Kong



061170

70 Hens White choc 3,1 x 3,5 cm
N/A: USA, China, Japan



NEW 098278

130 Decorations White Choc "Hop" 4,95 x 2,6 cm
N/A: China, Japan



070090

90 Rabbits White choc "Endimanchés" 2 designs • N/A: UAE, Saudi Arabia, Qatar, Kuwait, Bahrain, Oman



088084

70 Eggs White Choc "Be happy" 2 designs
N/A: China, Japan, Hong Kong



088231

96 Fishes White Choc "La bande à Maurice" 5 designs
N/A: USA, China, Japan, South Korea





DECORATIONS



061069
154 Eggs White choc 3 designs - N/A: China, UAE, Saudi Arabia, Qatar, Kuwait, Bahrain, Oman, Hong Kong



NEW 098168
110 Rectangles White choc "Easter" 7 x 2 cm - N/A: USA, China



NEW 098281
80 Decorations White choc "Easter round" 4,9 x 4,6 cm - N/A: China, Japan, Hong Kong

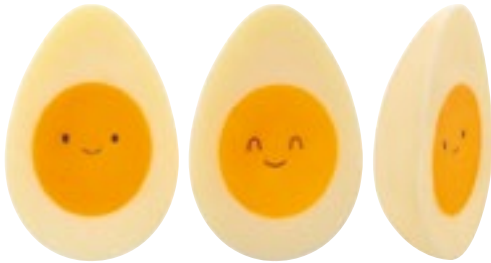

088085
126 Half-shells Eggs White Choc "Tête d'œuf" 2 designs 2,3 x 3,4 cm - N/A: China, Japan, South Korea, Hong Kong



088129
120 Eggs White choc "Silhouettes" 3 designs 2,2 x 3 cm - N/A: USA, China, Japan, Hong Kong



087046
114 Carrots White choc 2 designs 1,6 x 4,1 cm - N/A: China, Japan, Hong Kong



087067
48 Fried eggs White choc 2 designs - N/A: USA, China, Japan, South Korea



088128
66 Fishes White choc "Azteques" 3 designs 8,5 x 3,1 cm - N/A: USA, China, Japan, Hong Kong



088140
125 Carrots White choc "Crazy carrot" 1,6 x 5,4 cm N/A: USA, China, Japan, UAE, Saudi Arabia, Qatar, Kuwait, Bahrain, Oman, South Korea, Hong Kong

Free of colouring Worldwide • Azo

DECORATIONS



070169
135 Rabbit ears White choc
1,6 x 7 cm



070172
70 Rabbit ears White choc 4 x 4,6 cm •
N/A: UAE, Saudi Arabia, Qatar, Kuwait,
Bahrain, Oman



004886
70 Rabbit ears Milk choc 4 x 4,6 cm

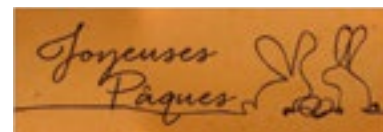

070168
120 Rectangles Choc BC "Linea" 5 x 1,7 cm



074293
110 Rectangles Dark choc "Happy Easter" 7 x 2 cm - N/A: China



088230
140 Hens White Choc "Gallinacés"
2 designs 3D 3,2 x 2,96 cm
N/A: USA, China, Japan, Qatar, South
Korea, Singapore



088137
150 Rabbits White choc "Garenne" 5 designs

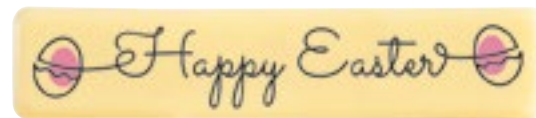

074294
140 Rectangles White choc "Happy Easter" 7 x 1,5 cm - N/A: Hong Kong



070167
144 Rabbit snouts White choc 3 cm



060907
180 Hens White choc 4 designs - N/A: USA, China



NEW 098279
140 Rabbit heads White choc "Mignon"
3,3 x 3,35 cm - N/A: China, Japan



087024
180 Rabbits White choc "Le quatuor" 2 x 3 cm
4 designs - N/A: USA, China, Japan, UAE, Saudi
Arabia, Qatar, Kuwait, Bahrain, Oman, South Korea



088088
75 Rectangles Dark Choc "Happy Easter" 5 x 3,3 cm
N/A: USA, China, Japan, UAE, Saudi Arabia, Qatar, Kuwait,
Bahrain, Oman, South Korea, Singapore



NEW 098272
90 Hens White choc "Basse-cour" 5 designs - N/A: China, Japan, Hong Kong



Free of colouring • Worldwide • Azo





NEW 098329 ●●●

12 Moulds "La bande à Lulu"
for 6 pieces 3 designs 11 x 13 cm
Th. : 8 cm - Weight: ± 110 g
N/A: USA, China, Japan, South Korea



KITS



074196 ● ● ● ●
 12 Moulds "Spider Lapin" for
 6 pieces 8,8 x 15 cm - Weight: ± 90 g
 N/A: USA, China, Japan, South Korea



🌐 **088091** ● ● ● ●
 12 Moulds "Floyd" for
 6 pieces 8,8 x 15 cm - Weight: ± 90 g
 N/A: USA, China, Japan, UAE, Saudi Arabia,
 Qatar, Kuwait, Bahrain, Oman, South Korea,
 Singapore



070176 ● ● ● ● ●
 9 Blisters lollipops "Lapin" and sticks for
 45 prints H. 5,7 cm - 5 designs - Weight:
 ± 15 g • N/A: UAE, Saudi Arabia, Qatar,
 Kuwait, Bahrain, Oman



074145 ● ● ● ●
 20 Moulds "Marguerite" for
 10 pieces 9,2 x 13,3 cm - Recto/verso
 Weight: ± 110 g - N/A: USA, China, Japan,
 Qatar, South Korea, Singapore



074002 ● ● ● ●
 18 Moulds "Chaton marin" for 9 pieces
 8,5 x 13 cm - Weight: ± 100 g
 N/A: China, Japan



061227 ● ● ● ● ●
 12 Moulds "Lapin Maneki" for 6 pieces
 8 x 12 cm - Weight: ± 100 g
 N/A: China, Japan

FLORENT
Margaillan



🌿 074089
12 Moulds "Œuf Mandala" for
6 pieces 10 x 15 cm - Th. 10 cm
Weight: ± 130 g

JÉRÔME
De Oliveira



🌿 074090
12 Moulds "Œuf Fleurs" for
6 pieces 10 x 15 cm - Th. 10 cm
Weight: ± 130 g



🌿 074086
12 Moulds "Œuf tissé" for
6 pieces 10 x 15 cm - Th. 10 cm
Weight: ± 130 g

JÉRÔME
Chausse



🌿 074092
12 Moulds "Œuf vague" for
6 pieces 2 designs - 8,2 x 13 cm
9,6 x 15 cm - Th. 8,2 - 9,6 cm
Weight: ± 85 g - 120 g

NICOLAS
Bernardé



🌿 010314
12 Moulds "Œufs Diamant" for 6 pieces
3 designs 21,5 x 14 cm - 14,2 x 9,4 cm
12,2 x 8 cm - Weight: ± 280 g
130 g - 90 g



🌿 088239
12 Moulds "Œufs textures"
for 6 pieces 9,8 x 15 cm - Th. 9,8 cm
Weight: ± 130 g

 **NEW** 098352

10 Moulds "Œufs volutes" for 5 pieces
8,2 x 13 cm - Th. 8,3 cm
Weight: ± 85 g





NEW 098353

10 Moulds "Œuf filaire" for 5 pieces
8,9 x 13 cm - Th. 8,9 cm
Weight: ± 90 g





NEW 098367
12 Moulds "Œuf pastille" for 6 pieces
10,4 x 15 cm - Th. ± 5 cm
Weight: ± 120 g



087188
16 Moulds "Sous-marin" for 8 pieces
15 x 10,5 cm - Th. 10,5 cm
Weight: ± 100 g



074085
12 Moulds "Cloche Ding Dong" for
6 pieces 10,5 x 11 cm - Th. 10,5 cm
Weight: ± 80 g



040150
2 Moulds "Tablette Lapins" for 8 pieces
15 x 14 cm - Th. 0,7 cm
Weight: ± 100 g



074323
12 Moulds "Friture sardine" for 216
pieces 3 designs 9 x 2,2 cm
Th. 0,7 cm - Weight: ± 7 g



074327
12 Moulds "Friture Lapinou" for
432 pieces 9 designs - Th. 1 cm
Weight: ± 6 g

KITS



🌿 074098
12 Moulds "Lapin Boule" for
6 pieces 11 x 11 cm - Th. 9,2 cm
Weight: ± 100 g



🌿 074093
12 Moulds "Lapin Peluche" for
6 pieces 10,3 x 14,7 cm - Th. 7,2 cm
Weight: ± 110 g



🌿 074108
12 Moulds "Teddy lapin" for 4 pieces
Body: 8,1 x 15 cm - Arm: 1,9 x 4,2 cm
Foot: 2,4 x 4,9 cm - Th. 7 cm
Weight: ± 100 g



🌿 040153
8 Moulds lapin "Facettes" for 4 pieces
13 x 11,5 cm - Ép. 7 cm - Weight: ± 115 g



🌿 074094
12 Moulds "Lapin Moustache" for
6 pieces 8,8 x 15 cm - Th. 5,6 cm
Weight: ± 90 g



🌿 074112
20 Moulds "Petits Rabbits" for
10 pieces 8 x 8 cm - Th. 5 cm
Weight: ± 30 g
🌿 074095
12 Moulds "Rabbits" for
6 pieces 12,5 x 12,5 cm - Th. 9 cm
Weight: ± 55 g

🍫 074307

12 Moulds "Fusée" for 6 pieces

8,7 x 14,9 cm - Th. 8,8 cm

Weight: ± 90 g

🍫 074309

12 Moulds "Lapin Astronaute" for 6 pieces

9,2 x 15 cm - Th. 7,1 cm

Weight: ± 80 g



 **NEW 098366**

6 Moulds "Pilotes de Pâques"
for 6 pieces 2 designs
3,9 x 7 cm and 3,9 x 5,7 cm
Th. ± 4,1 cm and 4,25 cm
Weight: ± 15 g - 20 g

 **NEW 098364**

18 Moulds "Bolide" for 6 pieces
20,4 x 9,2 cm - Th. ± 7 cm
Weight: ± 190 g

These moulds are neutral.

*Studio's
favorite*



KITS



🌱 074088

12 Moulds "Les Binoclaris" for
6 pieces 2 designs - 9,8 x 14 cm
9,8 x 10,9 cm - Th. 10,3 cm - 9,6 cm
Weight: ± 150 g



🌱 074083

12 Moulds "Euf Lapin" for
6 pieces 9,3 x 15 cm - Th. 9,5 cm
Weight: ± 130 g



🌱 074082

12 Moulds "Euf Oreille" for
6 pieces 9,5 x 19,5 cm - Th. 9,5 cm
Weight: ± 160 g



🌱 088240

12 Moulds "Lapin dodu" for 6 pieces
7 x 12 cm - Th. 8,1 cm
Weight: ± 70 g

These moulds are neutral.



🌱 074319

8 Moulds "Voiture Carotte"
for 6 pieces - 17 x 5,5 cm
Th. 5,7 cm - Weight: ± 80 g

These moulds are neutral.



🌱 088250

8 Moulds "Carotte" for
8 pieces 4,2 x 15 cm - Th. 4,2 cm
Weight: ± 55 g

 **NEW 098355**

12 Moulds coq "Cocorico" for 6 pieces
10,6 x 15,5 cm - Th. \pm 7,7 cm
Weight: \pm 90 g



 **NEW 098354**

12 Moulds poule "Cocoriquette" pour
6 pieces 11,55 x 12 cm - Th. \pm 7,52 cm
Weight: \pm 85 g





KITS



  **088241**
16 Moulds "La comtesse" for 8 pieces
12,4 x 14 cm - Th. 10 cm
Weight: ± 115 g



  **074305**
20 Moulds "Mouton pelote" for 10 pieces
7,7 x 8,8 cm - Th. 7,2 cm
Weight: ± 45 g







  **088251**
24 Moulds "Joyeux trio de poulettes"
for 12 pieces 3 designs - 6,65 x 7,35 cm
6 x 8,55 cm - 6,2 x 8,7 cm - Th. ± 5 cm
Weight: ± 30 g

FRANCK



Michel





  **074123**
10 Moulds "Boîte à œufs" for
10 pieces 15,5 x 10,5 cm
Th. 4 cm - Weight: ± 90 g



  **010328**
10 Moulds "Œufs" for 30 pieces
H. 6 cm - Weight: ± 16 g



  **074096**
12 Moulds "Poule et Coq" for
6 pieces 2 designs
12 x 14,3 cm - 11 x 18,5 cm
Th. 8 cm - 9 cm - Weight: ± 65 g - 80 g



  **074100**
24 Moulds "Poulettes" for 12 pieces
3 designs 9,4 x 9,9 cm - 8,5 x 10 cm
10,5 x 6,5 cm - Th. 6,4 cm
Weight: ± 30 g

  **010187**
1 Mould "Socle Poulettes"
for 15 pieces 4 x 4 cm - Weight: ± 8 g

JÉRÔME

De Oliveira

🌱 074104

12 Moulds "Hippocampe" for
6 pieces 9,8 x 13 cm - Th. 6 cm
Weight: ± 85 g



🌱 074120

16 Moulds "Boîte à sardines" for
8 pieces 11,5 x 7 cm - Th. 3,3 cm
Weight: ± 70 g

JÉRÔME

De Oliveira

🌱 074121

16 Moulds "Bord de mer" for 4 pieces 5 designs
Palms: 10 x 8 cm Th. 2,4 cm - Tubas: 4,5 x 10 cm Th. 0,7 cm
Bottles: 11 x 2,6 cm Th. 1,3 cm
Large masks: 5,5 x 3,1 cm Th. 1 cm
Small masks: 4,2 x 2,2 cm Th. 1 cm

VIANNEY

Bellanger

🌱 074078

12 Moulds "Baleine" for 6 pieces
17,5 x 8,7 cm - Th. 7,2 cm
Weight: ± 120 g



🌱 074084

16 Moulds "Poussin matelot"
for 8 pieces 4 designs
9,4 x 13 cm - 10,2 x 13 cm - 9,8 x 13 cm
Th. 7,6 cm - 7,5 cm - 8,5 cm - 8 cm
Weight: ± 120 g

NEW 098326 ●●●

12 Moulds "Flibustiers" for 6 pieces
3 designs 7,3 x 15 cm

Th. : ± 6,5 cm - Weight: ± 90 g

N/A: USA, China, Japan, South Korea, Singapore











074064
 30 Individual entremets moulds "Lapinou"
 for 120 pieces 10 x 8 cm - H. 4 cm
 Moulds with support jambs

ARNAUD
Lahrer





074245
 30 Individual entremets moulds
 "Euf bombé" for 120 pieces
 6 x 10 cm - H. 3 cm
 Moulds with support jambs

ÉTIENNE
Leroy









074068
 30 Entremets moulds "Nid"
 for 30 pieces ø 14 cm - H. 2 cm
 Moulds with support jambs

ARNAUD
Lahrer





074246
 30 Entremets moulds "Euf bombé"
 for 30 pieces 16 x 26 cm - H. 5 cm
 Moulds with support jambs





074065
 30 Entremets moulds "Lapin"
 for 30 pieces 14,4 x 17,8 cm - H. 7 cm
 Moulds with support jambs



NEW 098250

10 Moulds "Chameau" for 5 pieces

12 x 7,5 cm - Th. 4 cm

Weight: ± 75 g

ALEXANDRE
Thabard



MIDDLE EAST COLLECTION



087038
110 Drops Dark choc "Inde" 4,4 x 2,9 cm - 2 designs
N/A: China, Japan, Hong Kong



088097
88 Squares Dark Choc
"Crépuscule" 3 cm - N/A: USA,
China, Japan, UAE, Saudi Arabia,
Qatar, Kuwait, Bahrain, Oman, South
Korea, Hong Kong, Singapore



088096
120 Rectangles Dark Choc "Ornements" 6 x 2 cm - N/A: USA,
China, Japan, Qatar, Hong Kong, Singapore



088095
96 Squares White Choc "Calligraphie" 4 cm
N/A: USA, China, Japan, UAE, Saudi Arabia, Qatar,
Kuwait, Bahrain, Oman, South Korea, Singapore



088092
72 Rectangles White Choc "Ramadhan Kareem" 6 x 3 cm
N/A: USA, China, Japan, Qatar, South Korea, Singapore



088093
66 Rectangles Dark Choc "Moucharabieh"
4 x 2,9 cm - N/A: USA, China, Japan, Qatar,
South Korea, Hong Kong, Singapore

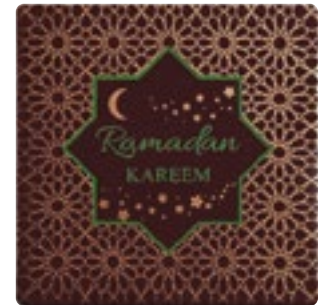

088094
96 Squares Dark Choc "Nuit d'Orient"
4 cm - N/A: USA, China, Japan, Qatar, South
Korea, Hong Kong, Singapore

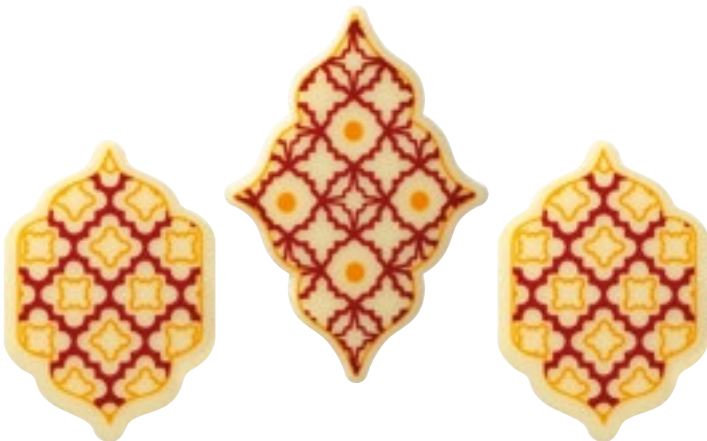

NEW 098334
90 Decorations White Choc "Moucharabieh" 2 designs - N/A: China, Japan, Hong Kong



NEW 098335
70 Squares Dark Choc "Eid Mubarak"
4 cm - N/A: USA, China, Japan, UAE, Saudi
Arabia, Qatar, Kuwait, Bahrain, Oman, South Korea

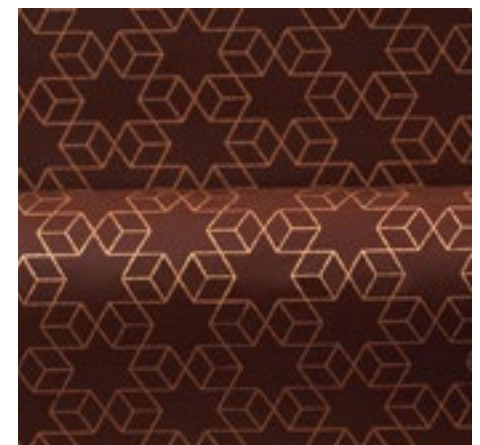

088017 ●●●●●
17 Transfer sheets "Alicatados" 40 x 25 cm - N/A: USA, China,
Japan, Qatar, South Korea, Singapore



EYES & ACCESSORIES



087027
120 Oval eyes compound 3 designs
3,4 x 1,7 cm



087028
171 Oval eyes compound
3 designs 2,2 x 1,3 cm



087029
266 Oval eyes compound with
lashes 4 designs 1,3 x 0,9 cm



070039
323 Round eyes compound
"Bruns" ø 1 cm



087030
323 Round eyes
compound "Bleus" ø 1 cm



070359
182 Cartoon eyes compound
"Marron" 3,5 x 2,3 cm - N/A: UAE,
Saudi Arabia, Qatar, Kuwait, Bahrain,
Oman

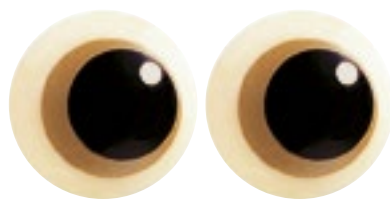

070038
108 Round eyes compound ø 2,5 cm



087026
165 Round eyes compound ø 1,7 cm

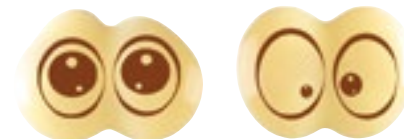

088136
171 Eyes White choc "Cartoon" 4 designs

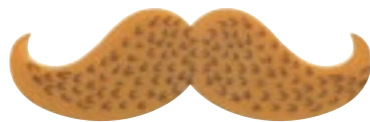
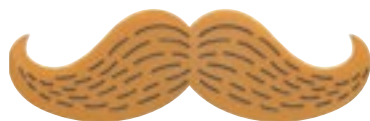
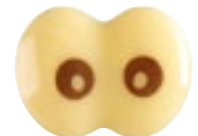

070165
150 Whiskers Choc BC 4 designs 4,8 x 1,5 cm

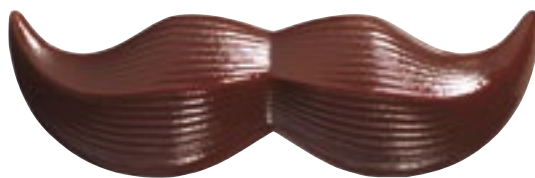

061177
105 Eyes White choc "Regards Comics" 7 designs 4,4 x 3,1 cm

070163
171 Eyes White choc 4 designs

025125
72 Whiskers Dark choc 7 x 2,2 cm



DECORATIONS

“NATURE“ DECORATIONS



070503
304 Mini leaves Dark choc "Traits verts" 1,5 x 2,9 cm - N/A: UAE, Saudi Arabia, Qatar, Kuwait, Bahrain, Oman



070274
304 Mini leaves White choc "Double nervure" 1,5 x 2,9 cm N/A: UAE, Saudi Arabia, Qatar, Kuwait, Bahrain, Oman



060920
160 Curved leaves White choc 2 designs - N/A: USA, China



061263
240 Curved leaves White Choc "Vertes" - N/A: China



070448
300 Mini leaves White choc "Vert et or" 4 designs - N/A: USA, China, Japan, UAE, Saudi Arabia, Qatar, Kuwait, Bahrain, Oman, South Korea



070292
100 Maple leaves White choc 2 designs - 6,1 x 5,7 cm 4,8 x 4,1 cm



070502
132 Classic leaves Dark choc "Traits verts" 2,9 x 5 cm N/A: UAE, Saudi Arabia, Qatar, Kuwait, Bahrain, Oman



070273
132 Classic leaves White choc "Double nervure" 2,9 x 5 cm - N/A: UAE, Saudi Arabia, Qatar, Kuwait, Bahrain, Oman



070104
135 Leaves Dark choc "Traits verts" 1,6 x 7 cm N/A: UAE, Saudi Arabia, Qatar, Kuwait, Bahrain, Oman



070272
135 Leaves White choc "Double nervure" 1,6 x 7 cm - N/A: UAE, Saudi Arabia, Qatar, Kuwait, Bahrain, Oman



088139
90 Leaves White choc "Chlorophylle" 2 designs 4,5 x 2,7 cm N/A: USA, China, Japan, UAE, Saudi Arabia, Qatar, Kuwait, Bahrain, Oman, South Korea, Hong Kong, Singapore



074277
110 Oak leaves Choc BC 3,1 x 5 cm



060264
45 Holly leaves Barley grass 3,7 x 5,5 cm N/A: USA, China

Free of colouring Worldwide • Azo



DECORATIONS



060292
 98 Curved oak leaves Dark choc
 3 designs 2,3 x 4,7 cm - 3 x 6 cm
 3,9 x 7,8 cm



060291
 98 Curved oak leaves Choc BC
 3 designs 2,3 x 4,7 cm - 3 x 6 cm
 3,9 x 7,8 cm





060294
 98 Curved holly leaves Dark choc
 3 designs 2,5 x 5 cm - 3,1 x 6,3 cm
 3,7 x 7,6 cm





060293
 98 Curved holly leaves Choc BC
 3 designs 2,5 x 5 cm - 3,1 x 6,3 cm
 3,7 x 7,6 cm

DECORATIONS



 **060911**
 160 Little curved feathers Choc BC 1,9 x 4 cm





 **004831**
 156 Leaves Dark choc 2 designs



070157
 132 Classic leaves Dark choc "Traits or"
 2,9 x 5 cm - N/A: UAE, Saudi Arabia, Qatar, Kuwait, Bahrain, Oman



 **045648**
 180 Small ribbed leaves Choc BC 4 designs



 **070353**
 100 Holly leaves Dark choc
 3,45 x 5,1 cm



 **003696**
 140 Holly leaves Dark choc 3 designs



061262
 240 Curved leaves White Choc "Bronze et Or"
 N/A: USA, China, Japan, Qatar, South Korea, Singapore

070432
 300 Leaves White Choc "Automne" 4 designs
 N/A: USA, China, Singapore



 **070293**
 180 Small ribbed leaves Dark choc 4 designs



070361
 154 Small maple leaves compound "Automne" 3 designs
 3,15 x 3,1 cm • N/A: China, UAE, Saudi Arabia, Qatar, Kuwait, Bahrain, Oman



088138
 108 Leaves White choc, Dark choc and Choc BC "Nervures"
 3 designs 4,5 x 2,7 cm - N/A: USA, China, Japan, UAE, Saudi Arabia, Qatar, Kuwait, Bahrain, Oman, South Korea, Singapore

 Free of colouring  Worldwide • Azo





DECORATIONS



070056
117 Daisies compound
ø 2,5 cm - N/A: China, UAE,
Saudi Arabia, Qatar, Kuwait,
Bahrain, Oman



070504
117 Daisies compound
"Rose" ø 2,5 cm •
N/A: China, Japan, UAE,
Saudi Arabia, Qatar, Kuwait,
Bahrain, Oman, South
Korea, Singapore



070055
176 Daisies
compound ø 2 cm
N/A: China, UAE, Saudi
Arabia, Qatar, Kuwait,
Bahrain, Oman



070152
176 Daisies
compound "Rose"
ø 2 cm • N/A: China,
Japan, UAE, Saudi
Arabia, Qatar, Kuwait,
Bahrain, Oman, South
Korea, Singapore



070384
176 Cherry blossom White choc "Sakura" 2 designs • N/A: China,
UAE, Saudi Arabia, Qatar, Kuwait, Bahrain, Oman



070363
176 Cherry blossom compound
"Rose" 3 cm • N/A: China,
UAE, Saudi Arabia, Qatar, Kuwait,
Bahrain, Oman



061313
192 Tiare flowers White
choc 2,5 x 2,5 cm
N/A: USA, China, UAE,
Saudi Arabia, Qatar,
Kuwait, Bahrain, Oman,
Hong Kong



NEW 098180
234 Flowers White choc "Osaka" 3 designs ø 2,2 cm
N/A: USA, China, Japan, UAE, Saudi Arabia, Qatar, Kuwait,
Bahrain, Oman, South Korea, Singapore

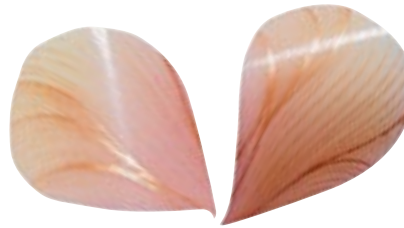

088119
392 Petals White Choc "Poudré" - N/A: USA, China, Japan,
UAE, Saudi Arabia, Qatar, Kuwait, Bahrain, Oman, South Korea,
Singapore



065215
392 Curved petals White choc "Jaune"
N/A: China, Japan



088116
117 Daisies White Choc "Acidulé" 3 designs ø 2,5 cm - N/A: USA, China, Japan,
Hong Kong



088117
176 Daisies compound "Printemps" 3 designs ø 3 cm
N/A: USA, China, Japan, UAE, Saudi Arabia, Qatar, Kuwait, Bahrain,
Oman, Hong Kong

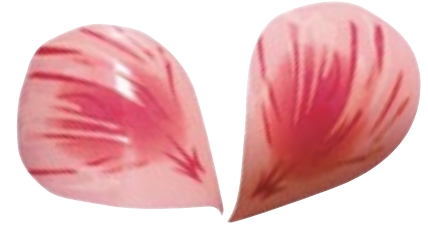

061308
392 Petals White Choc "Rose" - N/A: China, Japan

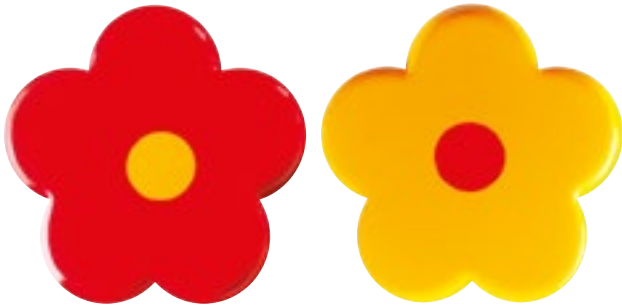

061315
96 Flowers White choc 4 designs ø 4 cm - N/A: China, Japan, UAE, Saudi Arabia, Qatar,
Kuwait, Bahrain



088232
176 Flowers compound "Frangipanier" 2 designs ø 3 cm - N/A: USA, China,
Japan, UAE, Saudi Arabia, Qatar, Kuwait, Bahrain, Oman



070052
234 Flowers White choc "Multicolores" 10 designs
ø 2,2 cm • N/A: China, UAE, Saudi Arabia, Qatar,
Kuwait, Bahrain, Oman

DECORATIONS

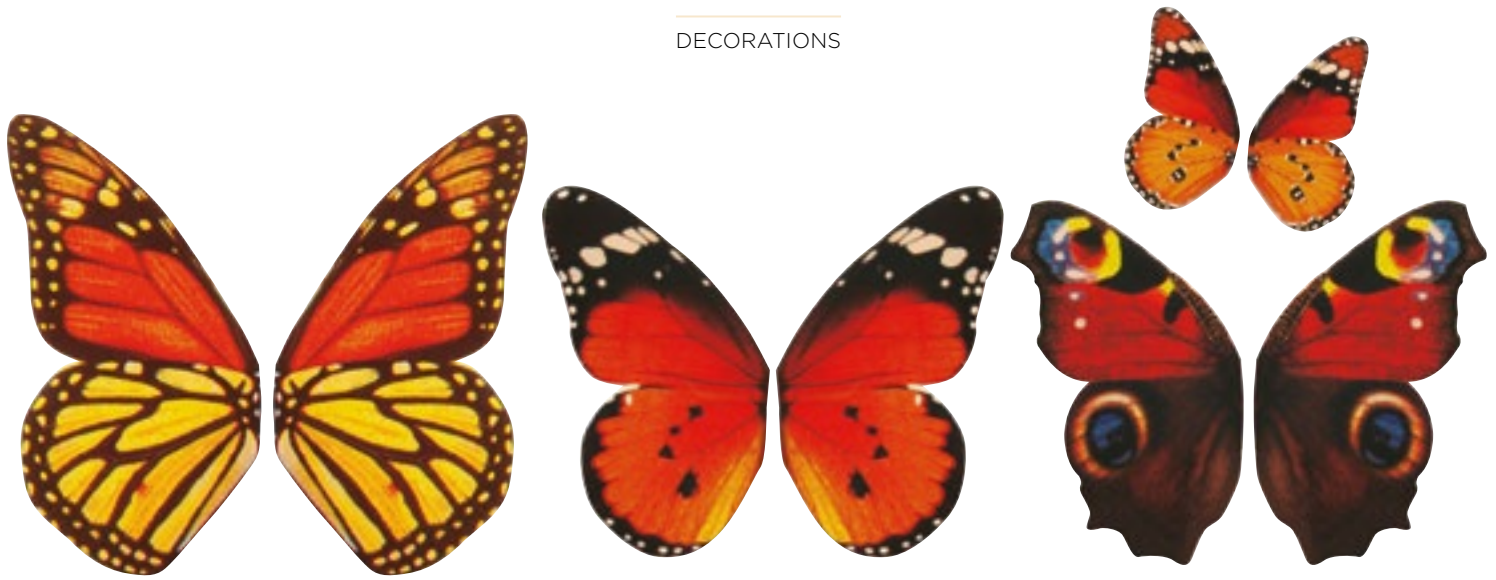

070106

220 Wings for 110 butterflies White choc 10 designs • N/A: UAE, Saudi Arabia, Qatar, Kuwait, Bahrain, Oman



070160

240 Wings for 120 butterflies White choc "Papillon" 12 designs • N/A: UAE, Saudi Arabia, Qatar, Kuwait, Bahrain, Oman

061179

240 Wings for 120 butterflies White choc "Papillon" 12 designs - N/A: China, Japan, Hong Kong



070155

170 Ladybugs White choc 2,1 x 1,9 cm •
N/A: UAE, Saudi Arabia, Qatar, Kuwait, Bahrain, Oman



070050

170 Bees White choc 2,1 x 1,9 cm •
N/A: UAE, Saudi Arabia, Qatar, Kuwait, Bahrain, Oman



088120

208 Butterflies White Choc "Rainbow" 4 designs 3 x 2,2 cm - N/A: USA, China, Japan, UAE, Saudi Arabia, Qatar, Kuwait, Bahrain, Oman, South Korea, Singapore

070505 ●●●●●

2 Blisters "Coccinelles" so 340 prints
2,1 x 1,9 cm • N/A: UAE, Saudi Arabia, Qatar,
Kuwait, Bahrain, Oman





EXTRA THIN DECORATIONS



074247

453 Christmas trees extra thin Dark choc, Choc BC and White choc - 9 designs - 2,5 x 3 cm - 3 x 3 cm - 4 x 4 cm

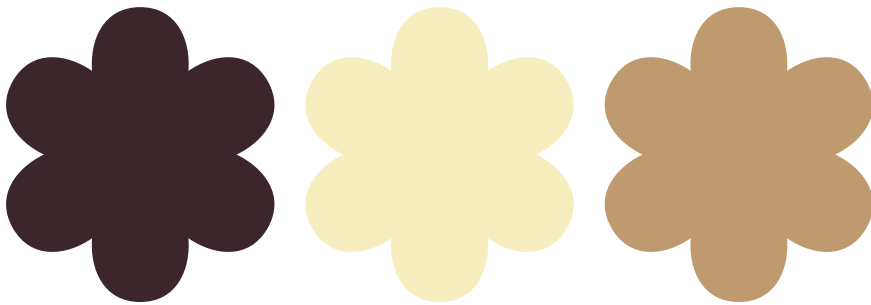

087059

168 Flowers extra thin Dark choc, Choc BC and White choc 3,55 x 3,9 cm



087032

300 Hearts extra thin Dark choc, Choc BC and White choc 4,2 x 4,7 cm

087033



250 Hearts extra thin marbled Dark and White choc several designs 4,2 x 4,7 cm

DECORATIONS





 **060934**
 360 Thin sticks Dark choc 12 x 0,4 cm



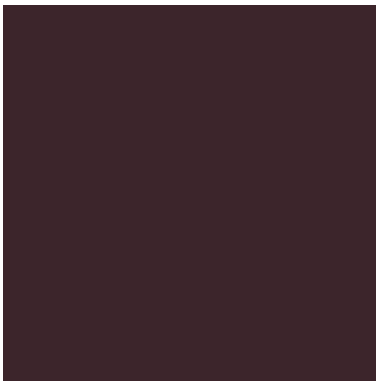

 **088233**
 315 Squares extra thin Dark choc 4 cm





 **030150**
 175 Squares extra thin Dark choc 5 cm



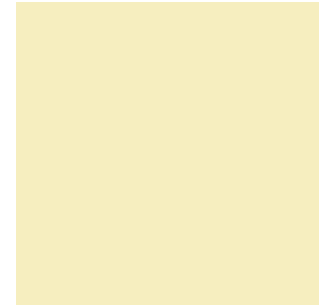

 **030151**
 175 Squares extra thin Milk choc 5 cm





 **088234**
 315 Squares extra thin White choc 4 cm



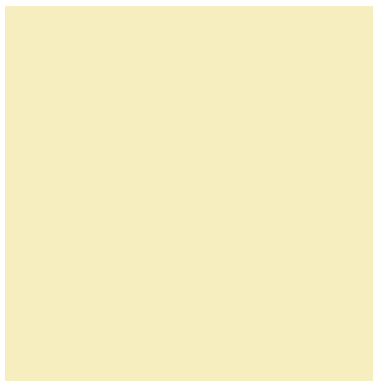

 **030152**
 175 Squares extra thin Choc BC 5 cm





 **030153**
 175 Squares extra thin White choc 5 cm



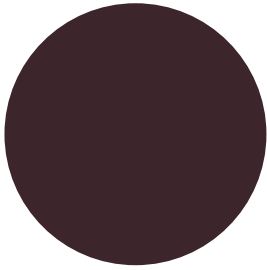

 **060296**
 175 Squares extra thin marbled Dark and White choc several designs 5 cm

DECORATIONS



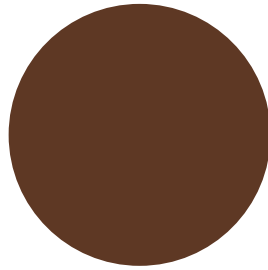

 **030154**
 325 Rounds extra thin Dark choc
 ø 3,5 cm



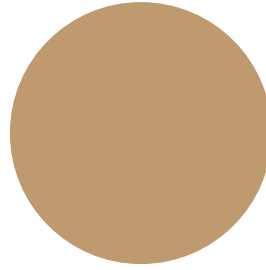

 **050282**
 325 Rounds extra thin Milk choc
 ø 3,5 cm



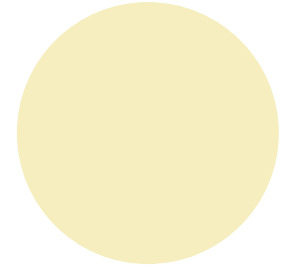

 **050283**
 325 Rounds extra thin Choc BC
 ø 3,5 cm



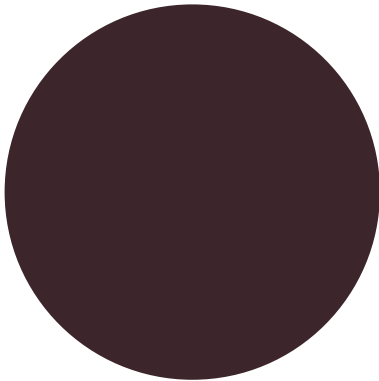

 **030155**
 325 Rounds extra thin White choc
 ø 3,5 cm



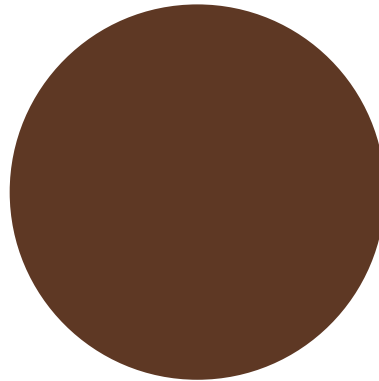

 **030146**
 180 Rounds extra thin Dark choc ø 5 cm





 **030147**
 180 Rounds extra thin Milk choc ø 5 cm



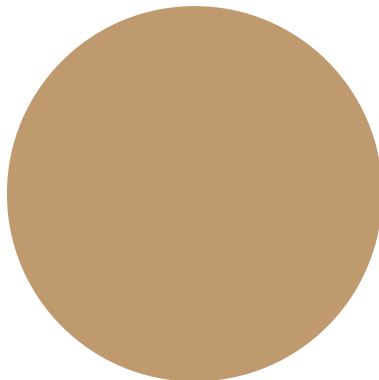

 **070295**
 180 Rounds extra thin marbled Dark and White choc several designs ø 5 cm



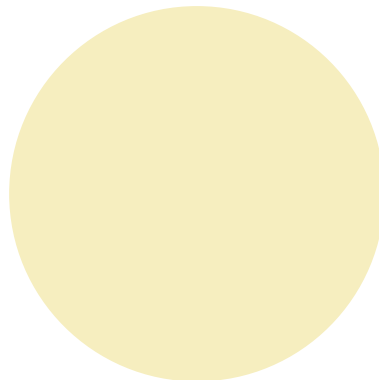

 **030148**
 180 Rounds extra thin Choc BC ø 5 cm

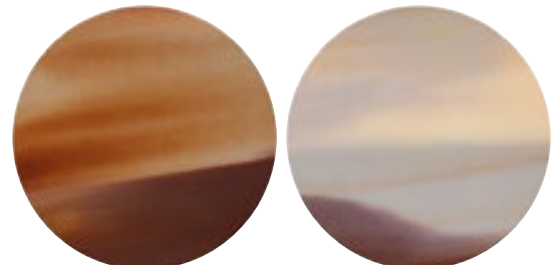

 **030149**
 180 Rounds extra thin White choc ø 5 cm



 **070294**
 325 Rounds extra thin marbled Dark and White choc several designs ø 3,5 cm



CURVED DECORATIONS



070107
 192 Farandoles White choc
 "Mille-feuilles"



061288
 192 Farandoles Dark Choc
 "Herbes folles" N/A: USA,
 China, Singapore



050188
 36 Curved rounds Choc BC ø 5 cm



050187
 36 Curved rounds Dark choc ø 5 cm



060367
 128 Curved petals Dark choc 5 x 2,2 cm



060366
 160 Small curved petals Dark choc 4 x 1,7 cm



060375
 176 Mini-clasp Dark choc 3,2 x 0,7 cm



060376
 176 Mini-clasp White choc 3,2 x 0,7 cm



061060
60 Curved sticks Dark choc
2 designs 17,5 x 1,1 cm
N/A: USA, China, Japan, UAE,
Saudi Arabia, Qatar, Kuwait,
Bahrain, Oman, South Korea,
Singapore



040009
76 Vanilla pods Dark choc
13,5 x 1,2 cm



004837
80 Branches
Dark choc
13,5 x 1,3 cm



061264
96 Sticks White
choc "Bambou"
12,8 x 1 cm
N/A: China



061265
144 Sticks White Choc "Sucre d'orge" 9 designs
13,75 x 0,6 cm - N/A: China, Japan, UAE, Saudi
Arabia, Qatar, Kuwait, Bahrain, Oman, Hong Kong

DECORATIONS



061266
144 Sticks White choc 8 designs
13,75 x 0,6 cm N/A: USA, China, Japan, Qatar,
South Korea, Singapore



061267
144 Sticks Dark choc 8 designs
13,75 x 0,6 cm N/A: USA, China, Japan,
Qatar, South Korea, Singapore



070147
144 Sticks White
choc "Mini brisures"
13,75 x 0,6 cm
N/A: Taiwan



 **087053**
144 Sticks White
choc "Lignes"
13,75 x 0,6 cm



061268
144 Sticks Dark
choc "Lignes"
13,75 x 0,6 cm
N/A: USA, China,
South Korea,
Japan, UAE, Saudi
Arabia, Kuwait,
Oman, Bahrain,
Qatar, Singapore

 Free of colouring  Worldwide • Azo

DECORATIONS



004799

90 Mini spoons Dark choc "Arabesques" 8 x 2 cm • N/A: China, UAE, Saudi Arabia, Qatar, Kuwait, Bahrain, Oman, South Korea, Taiwan, Hong Kong, Singapore



 **070042**

90 Mini spoons White choc "Arabesques" 8 x 2 cm



 **070364**

192 Peanuts Choc BC 4 x 1,75 cm



 **004746**

132 Mini tablettes Dark choc 4 x 3 cm

 **001456**

2 Blisters Mini tablettes so 132 prints
4 x 3 cm



061398

280 Squares White Choc
"Moucheté rouge" 3 cm - N/A:
USA, China, Japan



 **070096**

280 Squares White Choc
"Moucheté caramel" 3 cm
N/A: Taiwan



061284

280 Squares White Choc
"Moucheté vert" 3 cm
N/A: China, UAE, Saudi Arabia,
Qatar, Kuwait, Bahrain



087038

110 Drops Dark choc "Inde" 4,4 x 2,9 cm - 2 designs - N/A:
China, Japan, Hong Kong



061286

230 Triangles Dark Choc
"Arabesques" 3,3 x 5,5 cm
N/A: China



003285

567 Rounds Dark choc "Tendance" 8 designs ø 3 cm
N/A: USA, China, Japan, Qatar, South Korea, Singapore



065310

Coffee Beans Dark choc Shiny bronze 1,5 x 1,3 cm - 200 g
N/A: USA, China, Japan, Qatar, South Korea, Singapore



 **010399**

Coffee Beans Dark choc - 285 g
N/A: China, Japan





MIXED CIRCLES

Please note the decorations are not shown in real size.



070108
144 Mixed circles White choc "Moucheté caramel" 3 sizes
N/A: Taiwan



070149
144 Mixed circles White choc "Sucre d'orge" 3 sizes • N/A:
China, UAE, Saudi Arabia, Qatar, Kuwait, Bahrain, Oman



070223
144 Mixed circles White choc "Ronce de noyer" 3 sizes •
N/A: UAE, Saudi Arabia, Qatar, Kuwait, Bahrain, Oman



061292
144 Mixed circles White choc "Rayures roses" 3 sizes
N/A: China, Japan



061296
144 Mixed circles Dark choc "Cuivrés" 3 sizes
N/A: USA, China, Japan, Qatar, South Korea, Singapore

EMBOSSED PIECES



060942
 176 Rounds Dark choc embossed "Cabosse" ø 2,5 cm



060943
 176 Rounds Milk choc embossed "Café" ø 2,5 cm



060944
 176 Rounds Choc BC embossed "Miel" ø 2,5 cm



074268
 72 Butterflies wings Dark choc embossed 2 designs 3,2 x 4,5 cm



050280
 45 Rectangles Dark choc embossed "Joyeux anniversaire" 7 x 1,5 cm



087101
 100 Hearts White choc embossed "Je t'aime" 5,85 x 5,4 cm



045733
 528 Flowers Dark choc embossed white 8 designs ø 2,5 cm





All of our chocolate
pieces can be
personalized in
your language.
Contact-us!





070507

70 Rectangles Dark choc "Happy Anniversary" 7 x 1,5 cm
N/A: UAE, Saudi Arabia, Qatar, Kuwait, Bahrain, Oman



061377

70 Rectangles Dark choc "Joyeux Anniversaire" 7 x 1,5 cm N/A: China



070506

36 Ovals Dark choc "Happy Birthday" 6,2 x 3,7 cm - N/A: UAE, Saudi Arabia, Qatar, Kuwait, Bahrain, Oman

087063

72 Ovals Dark choc "Happy Birthday" 6,2 x 3,7 cm - N/A: China, Japan, Hong Kong



061378

152 Candles White choc 6 designs 0,8 x 6,6 cm - N/A: China, UAE, Saudi Arabia, Qatar, Kuwait, Bahrain, Oman, Hong Kong

DECORATIONS

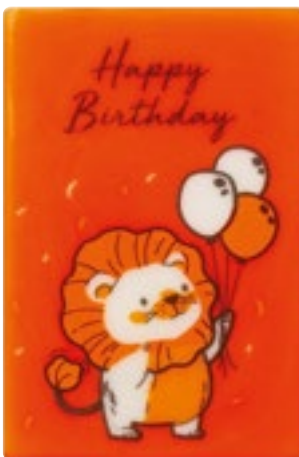

NEW 098187

64 Rectangles Compound "Happy Birthday" 2 designs 4 x 6 cm - N/A: China, Japan, UAE, Saudi Arabia, Qatar, Kuwait, Bahrain, Oman, Hong Kong



070260

75 Rectangles Dark choc "Happy birthday" 6 x 3,5 cm
N/A: UAE, Saudi Arabia, Qatar, Kuwait, Bahrain, Oman



003173

150 Rectangles Milk choc "Congratulations" 6 x 3 cm - N/A: UAE, Saudi Arabia, Qatar, Kuwait, Bahrain, Oman

HAPPY BIRTHDAY DECORATIONS



NEW 098264

20 Blisters "Chiffres" so 200 prints ± 4 x 6,5 cm (Numbers from 0 to 9)



061375

33 Banners Dark choc "Joyeux Anniversaire" 7,87 x 3,32 cm N/A: China

061376

165 Banners Dark choc "Joyeux Anniversaire" 7,87 x 3,32 cm N/A: China



061012

40 Rectangles White choc "Joyeux anniversaire" 7 x 5 cm
N/A: USA, China, Japan, Hong Kong

Free of colouring Worldwide • Azo



MARSHMALLOW DECORATIONS

Marshmallow: reminiscent of childhood sweetness and ideal for sumptuous decorations...
These decorations come in a range of special Bar decorations, composed of "Latte Art" discs to be deposited on the foam of your espresso and hot chocolate



070296

288 Marshmallow rounds "Latte art" 9 designs ø 3 cm - N/A: UAE, Saudi Arabia, Qatar, Kuwait, Bahrain, Oman



087007

120 Marshmallow rounds "Café latte" 6 designs ø 4 cm - N/A: USA, China, Japan, UAE, Saudi Arabia, Qatar, Kuwait, Bahrain, Oman, South Korea





DECORATIONS TO SPRINKLE

Discover edible dried flowers, lovingly selected by hand. You will be delighted by their beautiful natural colours and shapes. Liven up your dishes and cakes, whether it be desserts, macaroons, cupcakes, ice cream, chocolate truffles, whipped cream... These flowers are 100% natural, so please note that their colours may change depending on the season. *These products are the fruit of nature and are handpicked, which may limit the quantities available.*

DRIED FLOWERS



050293
50 Edible dried four-leaf clovers
N/A: USA, UAE, Saudi Arabia, Qatar, Kuwait, Bahrain, Oman



050294
50 Edible dried red vervain flowers
N/A: USA, UAE, Saudi Arabia, Qatar, Kuwait, Bahrain, Oman



050295
50 Edible dried blue vervain flowers
N/A: USA, UAE, Saudi Arabia, Qatar, Kuwait, Bahrain, Oman



050296
50 Edible dried white vervain flowers
N/A: USA, UAE, Saudi Arabia, Qatar, Kuwait, Bahrain, Oman



050297
50 Edible dried pink vervain flowers
N/A: USA, UAE, Saudi Arabia, Qatar, Kuwait, Bahrain, Oman



088211
Dried blue cornflower flowers 8 g - N/A: USA, UAE, Saudi Arabia, Qatar, Kuwait, Bahrain



088212
Dried pink cornflower flowers 8 g - N/A: USA, UAE, Saudi Arabia, Qatar, Kuwait, Bahrain



088213
Dried yellow marigold flowers 12 g
N/A: USA, UAE, Saudi Arabia, Qatar, Kuwait, Bahrain



088214
Mix of dried flowers 12 g - N/A: USA, UAE, Saudi Arabia, Qatar, Kuwait, Bahrain

**miam
miam
miam**



DECORATIONS TO SPRINKLE

Discover our new range of edible freeze-dried flowers, lovingly selected by hand. You will be delighted by their beautiful natural colours and shapes. Liven up your dishes and cakes, whether it be desserts, macaroons, cupcakes, ice cream, chocolate truffles, whipped cream... These flowers are 100% natural, so please note that their colours may change depending on the season.



088205
Freeze-dried lilac flowers 2 g - N/A: USA, UAE, Saudi Arabia, Qatar, Kuwait, Bahrain



088206
Freeze-dried elderflowers 5 g - N/A: USA, UAE, Saudi Arabia, Qatar, Kuwait, Bahrain



088207
Mini freeze-dried rose petals "Rose pâle" 2 g - N/A: USA, UAE, Saudi Arabia, Qatar, Kuwait, Bahrain



088208
Small freeze-dried rose petals "Violet" 2 g - N/A: USA, UAE, Saudi Arabia, Qatar, Kuwait, Bahrain



088209
Small freeze-dried rose petals "Rose vif" 2 g - N/A: USA, UAE, Saudi Arabia, Qatar, Kuwait, Bahrain



088210
Large freeze-dried rose petals "Rose pâle" 2 g - N/A: USA, UAE, Saudi Arabia, Qatar, Kuwait, Bahrain



DECORATIONS TO SPRINKLE

DECORATIONS TO SPRINKLE

FRUIT PIECECS



050225
Whole raspberries - 60 g



045005
Strawberry pieces - 80 g
N/A: Taiwan



045006
Raspberry pieces - 80 g

CRIPSY



060951
Coco Crispy - 150 g



060949
Strawberry Crispy - 200 g
N/A: Taiwan



060950
Raspberry Crispy - 200 g



070589
Lime crispy - 180 g

CRIPSY WETPROOF



088141
Strawberry Crispy wetproof 400 g
N/A: Taiwan



088142
Raspberry Crispy wetproof 400 g



088143
Lime Crispy wetproof 350 g

Ideal to bring **texture** with a pure taste of fruit, **moisture resistant**, they can be used in decoration or even in inclusion, topping...

MUST-HAVE!



DECORATIONS TO SPRINKLE

MERINGUETTES
& MINI MERINGUES



NEW 098298

Meringuettes coated gold - 350 g
N/A: USA, China, Japan, Qatar, South Korea



065293

Meringuettes coated red - 350 g
N/A: USA, China, Japan, South Korea



060953

Meringuettes coated white choc
350 g - N/A: USA, China, Japan



060952

Meringuettes egg-free - 250 g
N/A: USA



060343

Mini meringues coated white choc
210 g - N/A: China, Japan



060345

Mini meringues coated dark choc
210 g - N/A: China, Japan



060344

Mini meringues coated milk choc
210 g - N/A: China, Japan



060346

Mini meringues coated white, dark
and milk choc - 210 g
N/A: China, Japan



DECORATIONS TO SPRINKLE

HAZELNUTS & ALMONDS



NEW 098192
Golden chips (hazelnuts & almonds)
200 g - N/A: USA, China, Japan, Qatar,
South Korea



010437
Bronze chips (hazelnuts & almonds)
200 g - N/A: USA, China, Japan, Qatar,
South Korea, Singapore



OTHER PACKAGING
OPTIONS ARE
AVAILABLE
UPON REQUEST
Contact-us!

CARAMEL CHIPS



060954
Caramel chips - 350 g N/A: USA



004628
Isigny caramel chips - 250 g

CRISPY SPANGLES



NEW 098194
Golden crispy spangles - 500 g
N/A: USA, Canada, China, Japan, Qatar,
South Korea, Singapore



060565
Bronze crispy spangles - 500 g
N/A: USA, Canada, China, Japan, Qatar,
South Korea, Singapore

CHIPS



070267
Chocolate chips - 500 g



060948
Cocoa nibs - 350 g

“Kipetti” crackles and pops in your mouth. Add them to your chocolates, your cups or just about anything... Kipetti enrobed in chocolate: Chocolate protects the Kipetti from moisture thus making it possible to incorporate them into moist mixtures.

KIPETTIS



004557
Kipetti coated - 1 kg
N/A: USA



004631
Kipetti coated bronze - 250 g
N/A: USA, China, Japan, Qatar, South
Korea, Singapore



NEW 098191
Kipetti coated gold - 250 g
N/A: USA, China, Japan, Qatar, South
Korea, Singapore



004638
Kipetti nature - 1 kg
N/A: USA



Mini balls average size: $\varnothing \pm 0,3$ cm
Crunchies average size: $\varnothing \pm 0,5$ cm

DECORATIONS TO SPRINKLE

MINI BALLS



010427
Mini balls silver - 220 g
N/A: USA, Canada, China, Japan, UAE,
Saudi Arabia, Qatar, Kuwait, Bahrain,
Oman, South Korea, Singapore



010431
Mini balls gold - 220 g
N/A: USA, Canada, China, Japan, UAE,
Saudi Arabia, Qatar, Kuwait, Bahrain,
Oman, South Korea, Singapore

CRUNCHIES

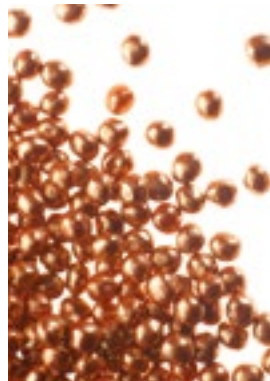

010397
Crunchies bronze - 170 g
N/A: USA, Canada, China, Japan, Qatar,
South Korea, Singapore



010426
Crunchies purple - 170 g
N/A: Canada, China, Japan, UAE, Saudi
Arabia, Qatar, Kuwait, Bahrain, Oman,
South Korea, Singapore



010411
Crunchies pink - 170 g •
N/A: Canada, China, Japan, UAE, Saudi
Arabia, Qatar, Kuwait, Bahrain, Oman,
South Korea, Singapore



NEW **098190**
Crunchies gold - 170 g
N/A: USA, Canada, China, Japan, Qatar,
South Korea, Singapore

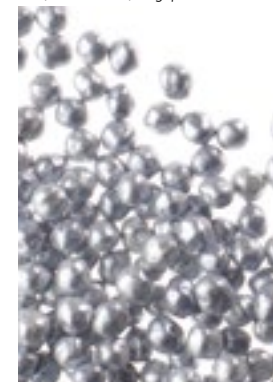

010412
Crunchies silver - 170 g
N/A: Canada, China, Japan, UAE, Saudi
Arabia, Qatar, Kuwait, Bahrain, Oman,
South Korea, Singapore



045656
Crunchies ruby - 170 g
N/A: USA, Canada, China, Japan, South
Korea, Singapore



010440
Crunchies dark - 500 g
N/A: Canada, China, Japan



010379
Crunchies milk - 500 g
N/A: Canada, China, Japan



010380
Assorted crunchies black, milk and
white - 500 g - N/A: Canada, China,
Japan

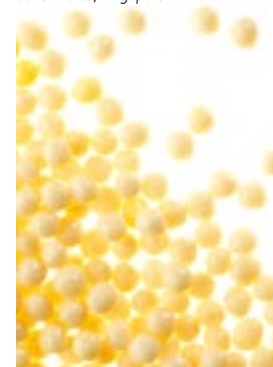

010441
Crunchies white - 500 g
N/A: Canada, China, Japan



060554
White hails (hazelnuts coated)
250 g



060555
Maxi hazelnuts silver - 250 g
N/A: USA, China, Japan, UAE, Saudi
Arabia, Qatar, Kuwait, Bahrain, Oman,
South Korea, Taiwan

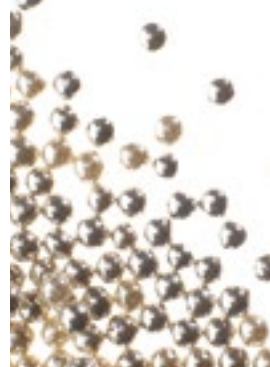

010414
Silver balls - 250 g - N/A: USA, China,
Japan, UAE, Saudi Arabia, Qatar, Kuwait,
Bahrain, Oman, South Korea, Taiwan

010388
Assorted crunchies black, milk and
white - 2,5 kg - N/A: Canada, China,
Japan

Free of colouring Worldwide • Azo

DECORATIONS TO SPRINKLE

FLOWER CHIPS

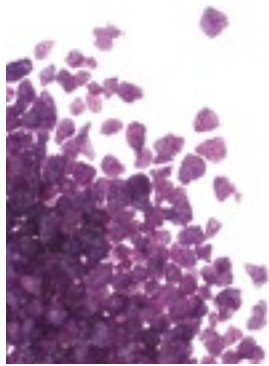

008695

Violet chips - 250 g - N/A: USA, China, Japan, South Korea



008693

Rose chips - 250 g - N/A: USA, China, Japan

HEARTS



045675

White choc hearts 0,9 cm - 200 g



074335

Sugar hearts shiny ruby 0,6 cm 200 g
N/A: USA, Canada, China, Japan, South Korea, Taiwan, Singapore

CONFETTIS



074336

Sugar mini-confetti shiny bronze
ø 0,4 cm - 200 g - N/A: USA, Canada, China, Japan, Qatar, South Korea, Taiwan, Singapore

STARS



045668

Chocolate stars shiny silver 0,9 cm 200 g - N/A: USA, China, Japan, UAE, Saudi Arabia, Qatar, Kuwait, Bahrain, Oman, South Korea, Singapore



045669

Chocolate stars shiny bronze 0,9 cm - 200 g - N/A: USA, China, Japan, Qatar, South Korea, Singapore



NEW 098193

Chocolate stars shiny gold 0,9 cm - 200 g - N/A: USA, China, Japan, Qatar, South Korea, Singapore



045671

White choc stars 0,9 cm - 200 g



045670

Dark choc stars 0,9 cm - 200 g



045664

Mini white stars 3 mm - 200 g
N/A: Canada



**MIAM
C'EST
DÉLICIEUX**



SILVER & GOLD

In flakes, sheets or petals...
For the utmost in sophistication, sprinkle these precious touches of real gold and silver on your desserts, entremets or chocolates. Discover how our real gold threads can give an incomparable gleam to all your creations.



036141
Plier for gold



025235
Sprinkler



025227
25 Genuine gold leaves in book loose
8 x 8 cm - N/A: USA, Canada, China, Japan



025231
Genuine gold petals - 500 mg per box
N/A: USA, Canada, China, Japan



025233
Genuine gold chips - 1 g per box
N/A: USA, Canada, China, Japan



087085
Genuine gold powder - 1 g per box
N/A: USA, Canada, China, Japan



025228
25 Genuine silver leaves in book loose
8 x 8 cm - N/A: USA, China, Japan, South Korea, Taiwan



025232
Genuine silver petals - 500 mg per box - N/A: USA, China, Japan, South Korea, Taiwan



025234
Genuine silver chips - 1 g per box
N/A: USA, China, Japan, South Korea, Taiwan



087086
Genuine silver powder - 1 g per box
N/A: USA, China, Japan, South Korea, Taiwan



004574
1 Spray gold spangles
200 ml - N/A: USA, Canada, China, Japan, UAE, Saudi Arabia, Qatar, Kuwait, Bahrain, Oman



TRANSFER SHEETS



SEE INSTRUCTIONS ON OUR WEBSITE



088008 "Paisley" ●●●●●

17 Transfer sheets 40 x 25 cm - N/A: USA, China, Japan, Qatar, South Korea, Hong Kong, Singapore



060144 "Robusta scintillant" ●●●●●

17 Transfer sheets 40 x 25 cm - N/A: USA, China, Japan, UAE, Saudi Arabia, Qatar, Kuwait, Bahrain, Oman, South Korea, Singapore



007592 "Opulence" ●●●●●

17 Transfer sheets 40 x 25 cm - N/A: USA, China, Japan, UAE, Saudi Arabia, Qatar, Kuwait, Bahrain, Oman, South Korea, Singapore



007615 "Cuivre et argent" ●●●●●

17 Transfer sheets 40 x 25 cm - N/A: USA, China, Japan, UAE, Saudi Arabia, Qatar, Kuwait, Bahrain, Oman, South Korea, Singapore



087000 "Rondin" ●●●●●

17 Transfer sheets 40 x 25 cm - N/A: USA, China, Japan, UAE, Saudi Arabia, Qatar, Kuwait, Bahrain, Oman, South Korea, Singapore



NEW **098251** "Tissage" ●●●●●

17 Transfer sheets 40 x 25 cm - N/A: USA, China, Japan, Qatar, South Korea, Singapore



070204 "Mikado Or" ●●●●●

17 Transfer sheets 40 x 25 cm - N/A: UAE, Saudi Arabia, Qatar, Kuwait, Bahrain, Oman

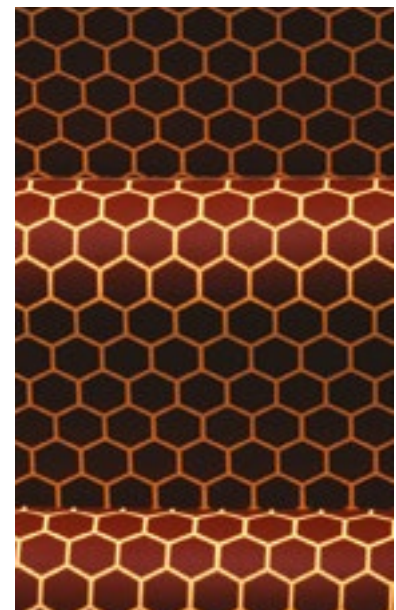

070201 "Alvéoles" ●●●●●

17 Transfer sheets 40 x 25 cm • N/A: UAE, Saudi Arabia, Qatar, Kuwait, Bahrain, Oman

Free of colouring | Worldwide • Azo ●●●●● Usable chocolates

TRANSFER SHEETS



065019 "Canopée" ●●●●●
17 Transfer sheets 40 x 25 cm
N/A: China, Singapore



061186 "Les cuivrés" ●●●●●
17 Transfer sheets 40 x 25 cm - N/A: USA, China,
Japan, UAE, Saudi Arabia, Qatar, Kuwait, Bahrain,
Oman, South Korea, Singapore



087002 "Cacao" ●●●●●
17 Transfer sheets 40 x 25 cm
N/A: China, Singapore



NEW **098259** "Linea" ●●●●●
17 Transfer sheets 40 x 25 cm
N/A: USA, China, Japan, Qatar, South Korea, Singapore



036144 "Paris Rubis" ●●●●●
17 Transfer sheets 40 x 25 cm - N/A: USA, China,
Japan, UAE, Saudi Arabia, Qatar, Kuwait, Bahrain,
Oman, South Korea, Singapore



061335 "Tout feu tout flamme" ●●●●●
17 Transfer sheets 40 x 25 cm • N/A: USA, China, Japan,
UAE, Saudi Arabia, Qatar, Kuwait, Bahrain, Oman, South
Korea, Singapore

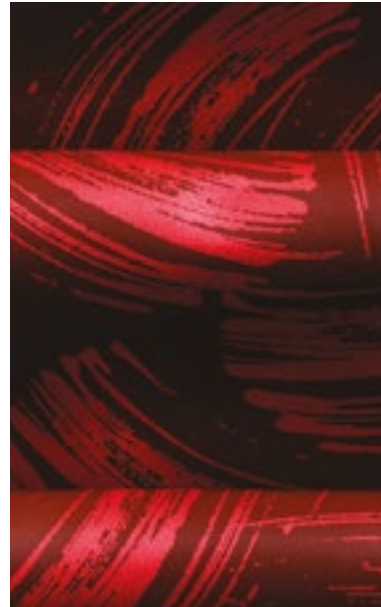

036142 "Londres rubis" ●●●●●
17 Transfer sheets 40 x 25 cm - N/A: USA, China,
Japan, UAE, Saudi Arabia, Qatar, Kuwait, Bahrain,
Oman, South Korea, Singapore

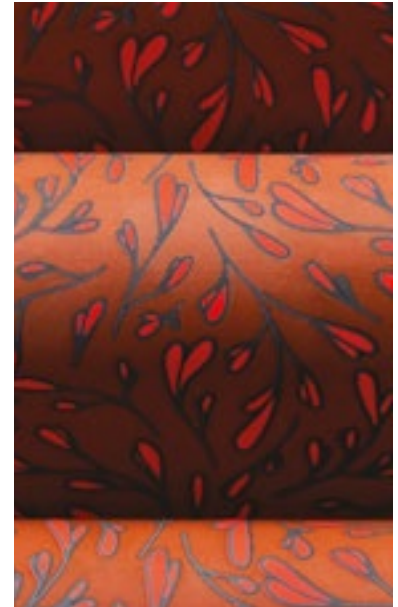

NEW **098255** "Amour toujours" ●●●●●
17 Transfer sheets 40 x 25 cm - N/A: China, Japan





TRANSFER SHEETS



088015 "Bouquet Floral" ● ● ● ● ●
17 Transfer sheets 40 x 25 cm
N/A: China, Japan, Hong Kong



088018 "Wagara" ● ● ● ● ●
17 Transfer sheets 40 x 25 cm - N/A: USA, China,
Japan, UAE, Saudi Arabia, Qatar, Kuwait, Bahrain,
Oman, South Korea, Hong Kong, Singapore



070218 "Un peu, beaucoup" ● ● ● ● ●
17 Transfer sheets 40 x 25 cm • N/A: UAE, Saudi Arabia,
Qatar, Kuwait, Bahrain, Oman

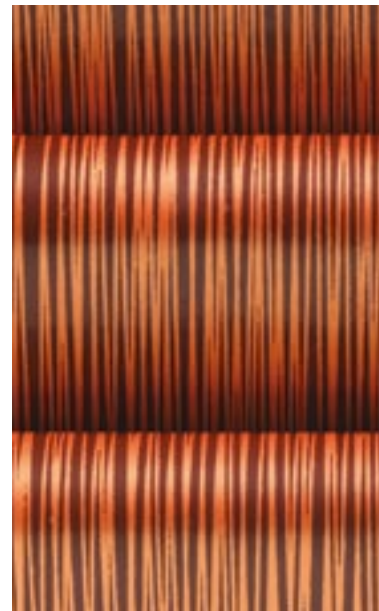

060151 "Pur éclat bronze" ● ● ● ● ●
17 Transfer sheets 40 x 25 cm - N/A: USA, China,
Japan, UAE, Saudi Arabia, Qatar, Kuwait, Bahrain,
Oman, South Korea, Singapore



070207 "Rayures" ● ● ● ● ●
17 Transfer sheets 40 x 25 cm • N/A: USA, China, Japan,
UAE, Saudi Arabia, Qatar, Kuwait, Bahrain,
Oman, South Korea, Singapore



088014 "Hippy" ● ● ● ● ●
17 Transfer sheets 40 x 25 cm - N/A: China, Japan

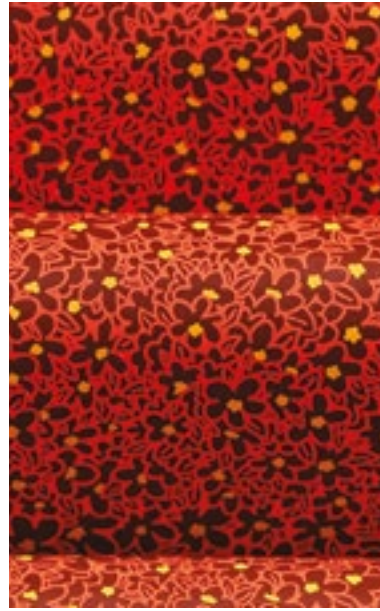

NEW 098254 "Champ fleuri" ● ● ● ● ●
17 Transfer sheets 40 x 25 cm - N/A: China, Japan,
Singapore

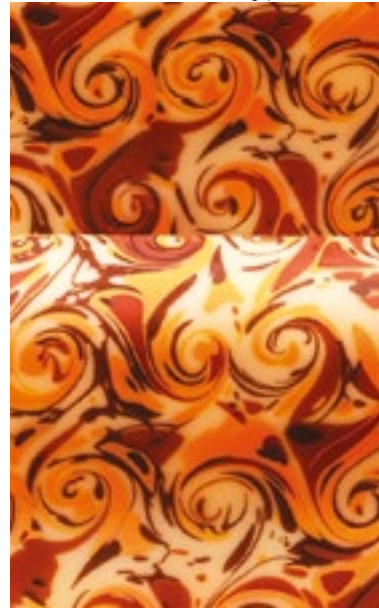

070211 "Papier reliure" ● ● ● ● ●
17 Transfer sheets 40 x 25 cm • N/A: UAE, Saudi Arabia,
Qatar, Kuwait, Bahrain, Oman

TRANSFER SHEETS



070200 "Notes de musique" ●●●●●
17 Transfer sheets 40 x 25 cm

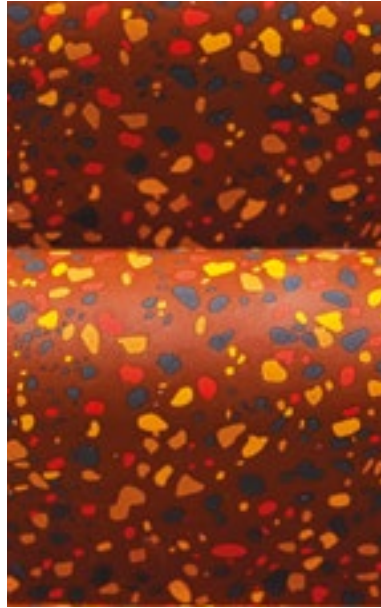

NEW 098256 ●●●●●
17 Transfer sheets "Terrazzo" 40 x 25 cm
N/A: China, Japan, UAE, Saudi Arabia, Qatar, Kuwait,
Bahrain, Oman, Singapore

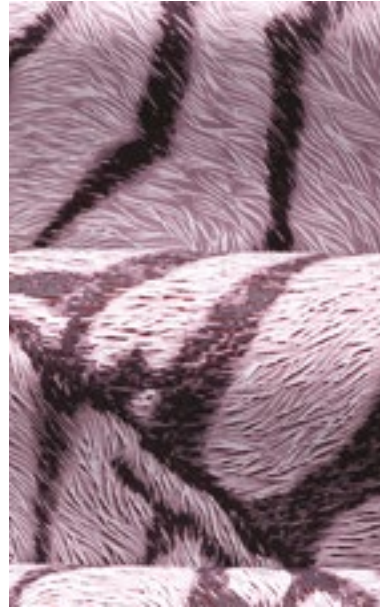

070209 "Zèbre" ●●●●●
17 Transfer sheets 40 x 25 cm - N/A: UAE, Saudi Arabia,
Qatar, Kuwait, Bahrain, Oman



NEW 098257 "Végétation" ●●●●●
17 Transfer sheets 40 x 25 cm - N/A: USA, China



070206 "Herbe" ●●●●●
17 Transfer sheets 40 x 25 cm - N/A: UAE, Saudi Arabia,
Qatar, Kuwait, Bahrain, Oman



061330 "Le peigne d'Eddy" ●●●●●
17 Transfer sheets 40 x 25 cm - N/A: China, UAE, Saudi
Arabia, Qatar, Kuwait, Bahrain, Oman



088004 "Agrumes" ●●●●●
17 Transfer sheets 40 x 25 cm



088003 "Citronnier" ●●●●●
17 Transfer sheets 40 x 25 cm - N/A: China





SUGGESTIONS

Make your Bonbons pop
with some Kipettis p. 185

TRANSFER CUTOUTS 4 X 4 CM



060878 ●●●●
1500 Transfer sheets "Cœur de Grenat" 3 Designs 4 x 4 cm - N/A: China, Japan



These individual transfer sheets centered on your chocolate bonbons will awaken your customers' tastebuds to the subtle flavours of the fillings and give your products a truly individual signature. These designs are available in 36 x 13 cm sheets or in 4 x 4 cm cutouts (remember to specify your preferred format in your order). A wide variety of additional patterns and flavours are available upon request.

SEE INSTRUCTIONS ON OUR WEBSITE



060876 ●●●●
1500 Transfer sheets "Cœur d'ambre" 3 Designs 4 x 4 cm

060877 ●●●●
1500 Transfer sheets "Cœur de Jade" 3 Designs 4 x 4 cm

070420 ●●●●
1500 Transfer sheets "Feuille gravure" 6 designs 4 x 4 cm - N/A: USA, China, Japan, UAE, Saudi Arabia, Qatar, Kuwait, Bahrain, Oman, South Korea



060875 ●●●●●
1500 Transfer sheets "Pollock" 4 x 4 cm - N/A: China, Singapore

060122 ●●●●●
1500 Transfer sheets "Fils scintillants" 2 designs 4 x 4 cm - N/A: USA, China, Japan, UAE, Saudi Arabia, Qatar, Kuwait, Bahrain, Oman, South Korea, Singapore

074192 ●●●●●
1500 Transfer sheets "Estampe Rubis" 6 designs 4 x 4 cm - N/A: USA, China, Japan, UAE, Saudi Arabia, Qatar, Kuwait, Bahrain, Oman, South Korea, Singapore

074193 ●●●●●
1500 Transfer sheets "Estampe Bronze" 6 designs 4 x 4 cm - N/A: USA, China, Japan, UAE, Saudi Arabia, Qatar, Kuwait, Bahrain, Oman, South Korea, Singapore



061195 ●●●●●
1500 Transfer sheets "Éclat or" 4 x 4 cm - N/A: USA, China, Japan, UAE, Saudi Arabia, Qatar, Kuwait, Bahrain, Oman, South Korea, Singapore

061194 ●●●●●
1500 Transfer sheets "Touche prestige or" 4 x 4 cm - N/A: USA, China, Japan, UAE, Saudi Arabia, Qatar, Kuwait, Bahrain, Oman, South Korea, Singapore

061193 ●●●●●
1500 Transfer sheets "Artiste" 4 designs, 4 x 4 cm - N/A: China, Japan

045797 ●●●●●
3000 Transfer sheets "Thé" 4 x 4 cm

045798 ●●●●●
3000 Transfer sheets "Caramel" 4 x 4 cm

045799 ●●●●●
3000 Transfer sheets "Café" 4 x 4 cm



STRUCTURE SHEETS FOR BONBON

Add eye-catching relief to your chocolates with our texture sheets...

Give traditional products more punch with these original, easy-to-use designs. After enrobing chocolate bonbons, just place the sheet on top, wait until the chocolate has set and remove.

STRUCTURE SHEETS - 27 Sheets 40 x 25 cm



060131
"Bulles"



011197
"Tressé"



011170
"Faux bois"



NEW 098299
"Croco"



088021
"Grain de café"



088022
"Cabosse"



011185
"Facettes"



011178
"Mailles"



045516
"Plumetis"



011180
"Averse"



011167
"Matelassé"



050062
"Fleurettes"



011193
"Lignes"



011164
"Petites arabesques"



011181
"Fibres"



011166
"Cabosses"



060873
"Craquelures"



065296
"Feuilles"



011175
"Damier"



011182
"Filaments"



011172
"Floral"



074288
"Étoiles"



060874
"Envol"



060132
"Strates"

Free of colouring • Worldwide • Azo • Usable chocolates



KITS

MARSHMALLOW MOULDS

Gourmets will be delighted with our new range of adorable marshmallow moulds!
All our moulds are suitable for manual or one-shot use, thanks to a center distance of 70 mm.



SEE INSTRUCTIONS ONLINE



NEW 098357

10 Marshmallow moulds "Rudolphe" for 80 pieces 5,2 x 8,5 cm - Th. : 1,77 cm



NEW 098358

10 Marshmallow moulds "Maggy" for 80 pieces 5,15 x 7,9 cm - Th. : 1,7 cm



NEW 098359

10 Marshmallow moulds "Santa" for 80 pieces 4,7 x 8 cm - Th. : 1,74 cm



088242

10 Marshmallow moulds "Fantôme" for 120 pieces 5,7 x 7 cm - Th. 2 cm



088243

10 Marshmallow moulds "Ourson" for 80 pieces 5 x 8 cm - Th. 2,2 cm

Free of colouring Worldwide • Azo



088244

10 Marshmallow moulds "Lapinou" for 80 pieces 4,3 x 8,5 cm - Th. 2,4 cm



KITS

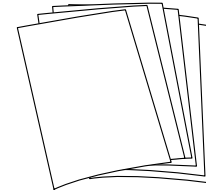

BLISTERS FOR LOLLIPOPS

061248 ●●●●●

9 Blisters lollipops "Nounours" and sticks for 45 prints 5 designs ø 5,5 cm - Weight: ± 15 g
N/A: China, Japan, UAE, Saudi Arabia, Qatar, Kuwait, Bahrain, Oman, Singapore

002138

50 Bags for Lollipops



087066 ●●●●●

9 Blisters lollipops "Licornes en vadrouille" and sticks for 45 prints 5 designs - Weight: ± 15 g - N/A: USA, China, Japan, UAE, Saudi Arabia, Qatar, Kuwait, Bahrain, Oman, South Korea, Singapore

061387 ●●●●●

9 Blisters lollipops "M. et M^{me} Teddy" and sticks for 45 prints 2 designs ø 5,5 cm
Weight: ± 15 g - N/A: USA, China, Japan, UAE, Saudi Arabia, Qatar, Kuwait, Bahrain, Oman, South Korea, Singapore

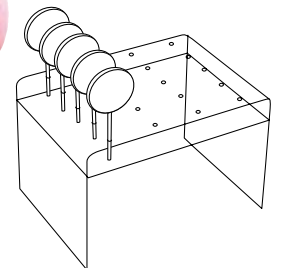

087034

9 Blisters lollipops "Super héros" and sticks for 45 prints 5 designs ø 5,5 cm - Weight: ± 15 g
N/A: USA, China, Japan, South Korea

070014 ●●●●●

9 Blisters lollipops "Licornes" and sticks for 45 prints 2 designs
H. 6 and 7,4 cm - Weight: ± 22 g • N/A: UAE, Saudi Arabia, Qatar, Kuwait, Bahrain, Oman

004560

1 Display for Lollipops for 20 pieces
25 x 18 cm - H. 16,5 cm

Free of colouring • Worldwide • Azo • Usable chocolates

KITS



QUENTIN
Bailly

- 040159
9 Blisters lollipops "Souvenirs d'enfance" and sticks for 45 prints
3 designs 2,6 x 8,5 cm - Th. 1,2 cm - Weight: ± 15 g



- 074166
9 Blisters lollipops "Les Dinos" and sticks for 45 prints 5 designs - Weight: ± 15 g



- 070389
9 Blisters lollipops "Jouets d'Antan" and sticks for 45 prints - 5 designs - Weight: ± 15 g

- NEW** 098321
9 Blisters lollipops "Pirates" and sticks for 45 prints 5 designs - Weight: ± 15 g



- 074165
9 Blisters lollipops "Fleurs" and sticks for 45 prints 3 designs - Weight: ± 15 g

- 060206
9 Blisters lollipops "Rêves de Licorne" and sticks for 45 prints 3 designs - Th. 1,3 cm Weight: ± 15 g

Free of colouring • Worldwide • Azo



KITS



🌿 060208

10 Moulds "Hiboux" for 5 pieces
10,7 x 12 cm - Th. 9,7 cm
Weight: ± 120 g



🌿 070424

12 Moulds "Teddy bear" for 4 pieces
8,6 x 13,4 cm - 2,8 x 6,4 cm - 2,4 x 5 cm
Th. 6,9 cm - Weight: ± 100 g



🌿 074103

12 Moulds "Licorne" for 6 pieces
11,4 x 12,5 cm - Th. 7,5 cm
Weight: ± 85 g



🌿 065089

10 Moulds "Renard sur son 31" for
5 pieces 11 x 12 cm - Th. 7,65 cm
Weight: ± 120 g



🌿 070427

8 Moulds Écureuil "Scrat" for 4 pieces
13,4 x 12,5 cm - Th. 7,5 cm
Weight: ± 100 g



🌿 087062

10 Moulds "Renard" for 5 pieces
8 x 13 cm - Th. 8 cm
Weight: ± 90 g

 **NEW** 098350

12 Moulds "Dino" for 6 pieces
13 x 13 cm - Th. 8,7 cm
Weight: ± 130 g



nouveau
biron
biron



NEW 098322

12 Moulds "Friture pieces d'or"
336 pieces 4 designs ± ø 3,4 cm
Weight: ± 5 g



**NEW** 098223

10 Transfer sheets "Back to school" for mugs
25,3 x 11 cm N/A: China, Japan, UAE, Saudi Arabia, Qatar, Kuwait, Bahrain, Oman

025191

4 Moulds "Mugs et anses" for 3 pieces ø 8 cm
H. 10 cm - Weight ± 75 g

NEW 098369

16 Moulds "Coffre au trésor" for 8 pieces 13 x 10 cm
Th. ± 8,5 cm - Weight: ± 130 g



074117

15 Moulds "Cornets de glace Oh zut" for 5 pieces - Cornet: 5,4 x 11,6 cm
Ice-cream: ø 8,2 cm - H. 4 cm
Weight: ± 60 g



087189

6 Moulds "Stylo" for 24 pieces
17,7 x 2,4 cm - Th. 2,3 cm
Weight: ± 20 g

CHRISTOPHE

Michalak

074080

16 Moulds "Van" for 6 pieces
19,4 x 7,2 cm - Th. 9 cm - Weight: ± 220 g

JULIEN

Boutonnet



045565

20 Moulds "Locomotive" for 4 pieces
15 x 12,5 cm H. 7 cm - Weight: ± 150 g

NEW 098362

12 Moulds "Tablette Éléments"
for 12 pieces 3 designs 15,5 x 7,5 cm
Th. ± 1,3 cm - Weight: ± 130 g

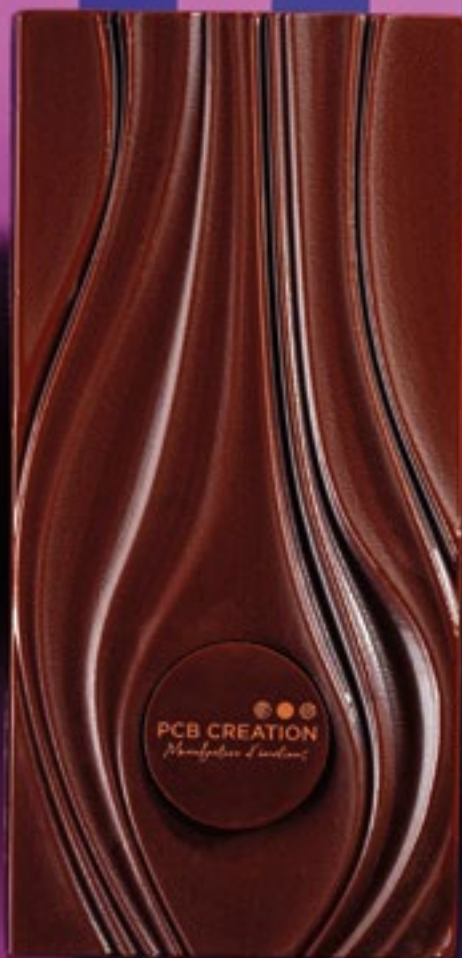
Studio's
favorite



CUSTOMIZE THESE TABLETS BY INSERTING
YOUR PERSONALIZED CHOCOLATE PIECE
(Ø 3 CM) INTO THE DESIGNATED SLOT.



 **NEW 098368**
 12 Moulds "Tablette pirate" for
 12 pieces ø 14 cm
 Th. 1,5 cm - Weight: ± 140 g

FLORENT
Margaillan



 **025192**
 2 Moulds "Cœurs" for 8 pieces
 15,5 x 6,2 cm - Weight: ± 70 g





 **074076**
 12 Moulds "Fleur" for 12 pieces ø 15 cm
 Th. 1,6 cm - Weight: ± 210 g



CHRISTOPHE
Michalak



 **009960**
 2 Moulds "Zodiaque" 12 designs
 for 12 pieces 12 x 12 cm - Weight: ± 65 g

 **004429**
 Packing boxes for square cards

 **004432**
 100 bags for square cards

Get Vintage!

Based on the same principle used for our cards, make vinyls to devour. The paper sleeve will protect and showcase your chocolate treats in a natural way.

  **NEW** 098356 ●●●●

10 Moulds "Chocvinyl" for 4 pieces
23 x 20,5 cm - Th. 5,6 cm
Weight: ± 480 g

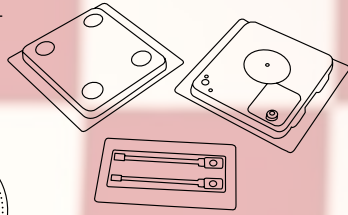

TRANSFER SHEETS & MOULDS FOR VINYL

Discover these products which work on a simple principle: one mould, a print to be put at the bottom.
 You just have to pour the chocolate and turn it out from the mould to obtain products
 which are fascinating by their illustrations and simplicity to make.
 If you do not have them yet, do not forget to order the moulds after having chosen your patterns...

SEE INSTRUCTIONS ON
 OUR WEBSITE



070436 ●●●●

24 Transfer sheets "Rock'n'Choc" for vinyls 6 designs ø 10,1 cm
 N/A: USA, China, Japan, UAE, Saudi Arabia, Qatar, Kuwait, Bahrain, Oman, South Korea, Singapore

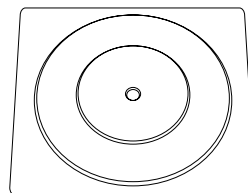

070428

12 Moulds Vinyle "33 Tours"
 ø 19,6 cm - Weight: ± 120 g



070583

24 Paper sleeves for Vinyl and protective
 films "33 Tours" 20 x 20 cm



NEW 098237 ●●●●

24 Transfer sheets "Mon truc en plus" for vinyls 3 designs ø 10,1 cm - N/A: China, Japan, Singapore



TRANSFER SHEETS & MOULDS FOR CHOC' TV

TRANSFER SHEETS & MOULDS FOR CHOC TV :

Choc TV dimensions: 14,54 x 11,5 cm - Weight: ± 130 g

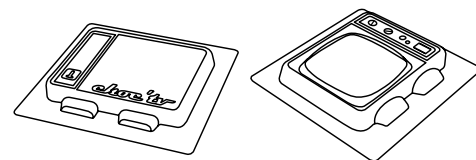

NEW 098375

16 Transfer sheets for choc TV "Hotel Tartesylvanie" 2 designs 8,65 x 7,75 cm N/A: China

NEW 098360

8 Moulds "Choc TV" for 4 pieces 14,54 x 11,5 cm
Th. 3,6 cm - Weight: ± 130 g



NEW 098376

16 Transfer sheets for choc TV "Christmas movies"
8,65 x 7,75 cm N/A: China, Japan

NEW 098377

16 Transfer sheets for choc TV "La La Crème" 8,65 x 7,75 cm
N/A: USA, China, Japan, UAE, Saudi Arabia, Qatar, Kuwait, Bahrain, Oman

NEW 098381

16 Transfer sheets for choc TV "Clara Frangipane"
8,65 x 7,75 cm N/A: China, Japan



NEW 098378

16 Transfer sheets for choc TV "Jurassic Tart"
8,65 x 7,75 cm N/A: USA, China, Japan, UAE, Saudi Arabia, Qatar,
Kuwait, Bahrain, Oman

NEW 098379

16 Transfer sheets for choc TV "Le Seigneur des gâteaux"
8,65 x 7,75 cm N/A: USA, China, Japan, UAE, Saudi Arabia, Qatar, Kuwait,
Bahrain, Oman, South Korea, Singapore

NEW 098380

16 Transfer sheets for choc TV "Le diable s'habille en Pralin"
8,65 x 7,75 cm N/A: USA, China, Japan

Free of colouring • Worldwide • Azo • Usable chocolates



PCB has developed a unique concept to easily make filled candies.
Place the first half-shell blister sheet in the magnetic mould.
The second blister sheet is placed in the other half of the mould.
Pipe the filling of your choice into the half shells, remove the protective
edge cover around the halfshell (no waste/no mess). Then simply close
both sides of the magnetic mould together and leave to cool for 4 hours.
This will give you wonderful decorated filled candies.



SEE INSTRUCTIONS ON OUR WEBSITE



HALF-SHELLS TO FILL



088201
630 Half-shells Eggs Dark choc
"Lignes" 2,3 x 3,4 cm (to create 315
eggs) N/A: USA, China, Japan, UAE, Saudi
Arabia, Qatar, Kuwait, Bahrain, Oman,
South Korea, Singapore



070175
630 Half-shells Eggs White choc "Traditionnels" 4 designs
2,3 x 3,4 cm (to create 315 eggs) • N/A: UAE, Saudi Arabia,
Qatar, Kuwait, Bahrain, Oman



070174
630 Half-shells Eggs White choc
"Taches" 3 designs 2,3 x 3,4 cm
(to create 315 eggs) • N/A: China,
UAE, Saudi Arabia, Qatar, Kuwait,
Bahrain, Oman



088202
630 Half-shells Eggs White choc «Zen» 3 designs 2,3 x 3,4 cm
(to create 315 eggs) N/A: USA, China, Japan, UAE, Saudi Arabia, Qatar,
Kuwait, Bahrain, Oman, South Korea, Hong Kong



NEW 098260
630 Half-shells Eggs White choc "Inca" 3 designs 2,3 x 3,4 cm (to create 315 eggs)



009964
1 Magnet form to make the filled eggs 63 prints
39,5 x 30 cm - H. 3 cm



009963
1 Magnet form to make the filled balls 63 prints
39,5 x 30 cm - H. 3 cm

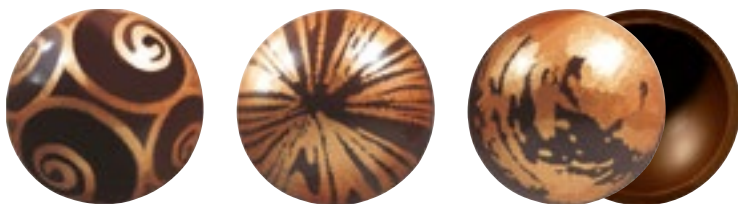

009025
630 Half-shells balls Dark choc "Éclat" 9 designs ø 2,6 cm - N/A: USA, China, Japan, UAE, Saudi Arabia, Qatar,
Kuwait, Bahrain, Oman, South Korea, Singapore

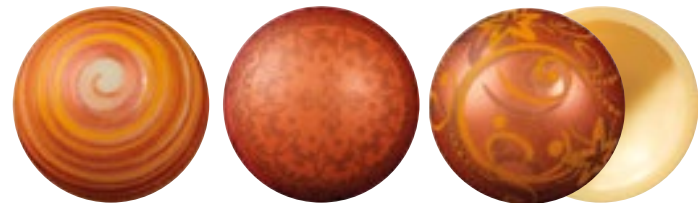

065216
630 Half-shells balls White choc "Tendance" 6 designs ø 2,6 cm
N/A: USA, China, Japan, UAE, Saudi Arabia, Qatar, Kuwait, Bahrain, Oman, South Korea, Hong Kong, Singapore

PCB has designed a full range of chocolate shells that can be used for all manner of products: Chocolate bonbons with extremely soft and delicate fillings. The very thin shell allows enrobing after filling if desired.



SHELLS TO FILL

CHOCOLATE SHELLS



SUGGESTIONS
Make your Bonbons pop with some Kipettis P. 185



008991
350 Round shells Dark choc
ø 2 cm - H. 1,2 cm



008988
350 Square shells Dark choc
2,2 x 2,2 cm - H. 1,2 cm



008948
504 Ball shells Dark choc ø 2,5 cm



008997
350 Round shells Milk choc
ø 3 cm - H. 1,2 cm



009001
350 Round shells White choc
ø 3 cm - H. 1,2 cm



008992
350 Round shells Dark choc
ø 3 cm - H. 1,2 cm



009002
280 Round shells White choc
ø 3 cm - H. 1,8 cm



008999
280 Round shells Dark choc
ø 3 cm - H. 1,8 cm



008989
350 Square shells Dark choc
2,7 x 2,7 cm - H. 1,2 cm



008990
350 Square shells Dark choc
3 x 3 cm - H. 0,8 cm



009000
280 Square shells Dark choc
2,7 x 2,7 cm - H. 1,8 cm



009013
350 Rectangle shells Dark choc
3,4 x 1,6 cm - H. 1,4 cm



008998
350 Oval shells Milk choc
3,4 cm - H. 1,2 cm



008993
350 Oval shells Dark choc
3,4 cm - H. 1,2 cm



040097
350 Round shells Choc BC
ø 3 cm - H. 1,2 cm



040099
280 Square shells Choc BC
2,7 x 2,7 cm - H. 1,8 cm



040098
280 Round shells Choc BC
ø 3 cm - H. 1,8 cm



SEE INSTRUCTIONS
ON OUR WEBSITE



POMPONS & POMPONETTES



CAUTION THESE PRODUCTS MUST BE FILLED AND FROZEN IN ORDER TO BE USED.

Pompons and Pomponettes are the fruit of a technique invented and perfected by PCB: the extra-thin shells can be filled with a wide variety of mixtures then frozen. Then just turn out as needed.

These shells will sate any sweet or savoury craving.

The Pompons can be filled with mousse or cake (like traditional entremets), ice-cream, coulis, cream cheese... Just freeze to create wonderful individual entremets that are already finely glazed and decorated. The thin shell is easily broken with a dessert spoon, making them so easy to enjoy.



009003

60 Dark Pompons "Kougelhopf"
ø 7,2 cm - H. 3,5 cm
N/A: China



009024

60 White Pompons
ø 7,2 cm - H. 3,5 cm



050067

60 Caramel pompons
ø 7,2 cm - H. 3,5 cm - N/A: Taiwan



009010

60 Dark Pompons "Traces" ø 7,2 cm
H. 3,5 cm - N/A: USA, China,
Japan, Qatar, South Korea, Singapore



008971

210 Dark Pomponettes bronze printing
ø 3,4 cm - H. 1,4 cm
N/A: USA, China, Japan, Qatar, South Korea,
Singapore



008964

210 White Pomponettes bronze printing
ø 3,4 cm - H. 1,4 cm
N/A: USA, China, Japan, Qatar, South Korea,
Singapore



008985

60 Dark Pompons "Arabesques"
ø 7,2 cm - H. 3,5 cm
N/A: USA, China, Japan, Qatar, South Korea,
Singapore





008949
48 Square shells Dark choc
4,6 x 4,6 cm - H. 4,5 cm



008950
54 Rectangles shells Dark choc
11,4 x 2,5 cm - H. 2,6 cm



061206
32 Dark choc Tubes "Étoiles" H. ± 8 cm - ø 3,3 cm



008644
36 Drop shells Dark choc "Ajourées"
9,5 x 5 cm - H. 4 cm





TART SHELLS

We are proud to represent real "Made in France" quality. That's why we would like to propose this range of tart shells. We have chosen to work with French partners and quality local products in order to better control traceability, limit the impact on the environment and above all stay in line with artisan craftsmanship. We want to highlight the purity of our carefully selected French ingredients (butter, flour, free range eggs..), and have removed all artificial flavourings and colourings that might interfere with the taste of your toppings.

GRAHAM

**060893**

189 Mini rounds Graham
ø 2,9 cm - H. 1,5 cm
N/A: China

**060894**

90 Medium rounds Graham
ø 5 cm - H. 1,7 cm N/A: China

**060895**

36 Large rounds Graham
ø 8 cm - H. 1,7 cm N/A: China

COCOA

**043152**

189 Mini rounds cocoa
ø 2,9 cm - H. 1,5 cm
N/A: China, Hong Kong



033526 *

210 Small rounds cocoa
ø 3,7 cm - H. 1,5 cm
N/A: Canada



033527 *

210 Small squares cocoa
3,4 x 3,4 cm - H. 1,5 cm
N/A: Canada



033528 *

36 Large rounds cocoa
ø 8 cm - H. 1,7 cm
N/A: Canada



033529 *

36 Large squares cocoa
6,9 x 6,9 cm - H. 1,7 cm
N/A: Canada

SWEET

**043151**

189 Mini sweet rounds
ø 2,9 cm - H. 1,5 cm
N/A: China, Hong Kong



033515 *

210 Small sweet rounds
ø 3,7 cm - H. 1,5 cm
N/A: Canada



033520

90 Medium sweet rounds
ø 5 cm - H. 1,7 cm



033517 *

210 Small sweet squares
3,4 x 3,4 cm - H. 1,5 cm
N/A: Canada



040192

Cones holder transparent 37 x 28 cm
H. 8 cm - 63 imprints



033522 *

36 Large slim sweet rounds
ø 8 cm - H. 1,7 cm
N/A: Canada

**033523**

60 Large slim sweet rounds
ø 8 cm - H. 1 cm
N/A: China



033524 *

36 Large sweet squares
6,9 x 6,9 cm - H. 1,7 cm
N/A: Canada



033525 *

90 Large sweet rectangles
10 x 3,5 cm - H. 1,7 cm
N/A: Canada



033521

90 Sweet cones ø 2,5 cm
H. 7,5 cm
N/A: USA, Canada



GLUTEN-FREE



033530 *
90 Medium rounds gluten-free
ø 5 cm - H. 2 cm
N/A: Canada, China, Japan, Taiwan



033531 *
36 Large rounds gluten-free
ø 8,5 cm - H. 2 cm
N/A: Canada, China, Japan, Taiwan

SAVOURY



060896
180 Casserole dish savoury
ø 5,1 cm - H. 1 cm
N/A: Canada



043150
189 Mini savoury rounds
ø 2,9 cm - H. 1,5 cm



033501 *
210 Small savoury rounds
ø 3,8 cm - H. 1,5 cm
N/A: Canada



033503 *
210 Small savoury squares
3,4 x 3,4 cm - H. 1,5 cm
N/A: Canada



033507 *
36 Large savoury rounds
ø 8 cm - H. 1,7 cm
N/A: Canada



033508 *
36 Large savoury squares
6,9 x 6,9 cm - H. 1,7 cm
N/A: Canada



033509 *
90 Large savoury rectangles
10 x 3,5 cm - H. 1,7 cm
N/A: Canada



040192
Cones holder transparent 37 x 28 cm
H. 8 cm - 63 imprints



033512 *
192 Carrot tulips
ø 3,2 cm - H. 1,5 cm
N/A: Canada



033513 *
192 Beetroot tulips
ø 3,2 cm - H. 1,5 cm
N/A: Canada



033514 *
192 Spinach tulips
ø 3,2 cm - H. 1,5 cm
N/A: Canada



033511 *
252 Barquettes Neutrals
6,9 x 3,3 cm - H. 0,9 cm
N/A: Canada



033510 *
252 Ebene savoury barquettes
6,9 x 3,3 cm - H. 0,9 cm
N/A: USA, Canada, China, South Korea

SAVOURY



033506
90 Sesame cones
ø 2,5 cm - H. 7,5 cm
N/A: USA, Canada, Japan, Hong Kong





NEW 098397
90 Basil cones ø 2,5 cm
H. 7,5 cm N/A: USA, Canada, China, Japan, Hong Kong



NEW 098398
90 Ebene cones ø 2,5 cm
H. 7,5 cm N/A: USA, Canada, China, Japan, Hong Kong



*Studio's
favorite*

NEW 098301  

1 Silicone mould "Bûche torsade"
for 1 piece 19,3 x 9,2 cm - H. 6,8 cm
Volume : 640 ml

SILICONE MOULDS

PCB Création now has a specialised workshop to create your silicone moulds:

We create and shape unique silicone moulds for you in our new specialised design office where our expert team use state-of-the-art equipment. A new service developed with one goal: to make the unique accessible to you. No minimum order (from a mould to several thousand), affordable equipment costs, different processes available, adapted to your requests, and short production times (2 weeks to create your prototype and 4 to 5 additional weeks to manufacture your mould or moulds).

PCB Création silicone moulds are made in our factory in Alsace, using premium silicone, produced in Europe, with remarkable mechanical properties. It resists temperatures from -40°C to +220°C, and even more in some cases.

Our team takes all your requirements into account to provide you with a tailor-made solution perfectly adapted to your needs (moulds for logs, desserts - individual or for sharing - or even moulds for chocolate, plaques, stamps, etc.).



NEW 098304  
1 Silicone mould "Bouchées élancées"
for 24 pieces ø 3,5 cm - H. 1,6 cm
Volume : 10 ml



FRANCK
Michel



NEW 098310  
1 Silicone mould "Bouchées coussin"
for 15 pieces 4,2 x 4,2 cm - H. 1,5 cm
Volume : 18 ml



NEW 098305  
1 Silicone mould "Bouchées concentriques"
for 28 pieces ø 3 cm - H. 1,9 cm
Volume : 11 ml



MARC
Rivière





088195  
1 Silicone mould "Torsade"
for 24 pieces ø 3 cm - H. 1,7 cm
Volume : 9,5 ml

THE + OF SILICONE MOULDS

- A WIDE VARIETY OF SHAPE DESIGN OPTIONS
- SUITABLE FOR COOKING AND FREEZING
- VERY RESISTANT
- EASY TO REMOVE FROM THE MOULD
- MADE IN FRANCE
- REUSABLE



SILICONE MOULDS





NEW 098307  
1 Silicone mould "Concentrique"
for 6 pieces ø 7 cm - H. 3,2 cm
Volume : 104 ml

PIERRE
Hermé





NEW 098312  
1 Silicone mould "Larme" for
6 pieces 9,2 x 5,7 cm - H. 4,3 cm
Volume : 92 ml



NEW 098308  
1 Silicone mould "Twist" for
6 pieces ø 7,5 cm - H. 3,5 cm
Volume : 120 ml



CHRISTOPHE
Michalak





NEW 098302  
1 Silicone mould "Rose" for
6 pieces ø 6 cm - H. 5,4 cm
Volume : 114 ml

FRANCK
Michel



NEW 098311  
1 Silicone mould "Cousin" for
6 pieces 7,7 x 7,7 cm - H. 3 cm
Volume : 120 ml







NEW 098300  
1 Silicone mould "Ourson" for
4 pieces 10,1 x 5,9 cm - H. 3 cm
Volume : 116 ml

SILICONE MOULDS







010119  
1 Silicone mould "Mini magnum"
for 8 pieces 6,8 x 3,7 cm P. 1,8 cm
004667  
50 Mini flat birch sticks 7,2 x 0,8 cm





010120  
2 Silicone moulds "Magnum"
for 12 pieces 9,2 x 4,8 cm P. 2,5 cm
004668  
50 Flat birch sticks 11,2 x 1 cm

JÉRÔME
De Oliveira



010051  
1 Silicone mould "Bouchon de parfum"
for 1 piece
010297  
1 Silicone mould "Parfum" for
6 pieces ø 8 cm H. 4 cm





088266  
1 Silicone mould "Gobelet"
for 6 pieces ø 6,7 cm - H. 5,6 cm
Volume : 142 ml



087078  
1 Silicone mould "Vrille"
for 6 pieces ø 7 cm - H. 4,5 cm
Volume : 120 ml

JEAN-PHILIPPE
Darcis





088196  
1 Silicone mould "Étoile"
for 6 pieces ø 7,5 cm - H. 4,5 cm
Volume : 102 ml



088265  
1 Silicone mould "Petite tarte"
for 6 pieces ø 7,4 cm - H. 1,7 cm
Volume : 67 ml



NEW 098314  
1 Silicone mould "Palet"
for 6 pieces ø 6,5 cm - H. 3 cm
Volume : 85 ml



098315
1 Silicone mould "Ovoïde"
for 9 pieces 8,2 x 4,3 cm - H. 3,2 cm
Volume : 79 ml



SILICONE MOULDS





NEW 098306  
 1 Silicone mould "Concentrique" for 1 piece
 ø 14,1 cm - H. 5,2 cm
 Volume : 690 ml

CHRISTOPHE
Michalak





NEW 098303  
 1 Silicone mould "Charlotte" for 1 piece
 ø 15,5 cm - H. 4 cm
 Volume : 466 ml



NEW 098309  
 1 Silicone mould "Twist" for 1 piece
 ø 14,3 cm - H. 5,7cm
 Volume : 725 ml



JEAN-PHILIPPE
Darcis



088197  
 1 Silicone mould "Étoile" for 1 piece
 ø 19,5 cm - H. 5 cm
 Volume : 776 ml

Studio's
favorite



NEW 098313  
1 Silicone mould "Bûche chalet"
for 1 piece 17,2 x 8,6 cm
H. 7,4 cm - Volume : 770 ml







SILICONE MOULDS

SILICONE MATS

Discover our new range of silicone mats!

Create original decorations with our silicone mats. Ideal for making Tuile biscuits or other decorations that will showcase your plated desserts and entremets with finesse and subtlety. **Use the QR code below to discover our recipe for plant-based Tuiles:**

We use a premium silicone made in France, suitable for contact with food.
Temperature range: -70°C/+200°C



 **NEW** 098401
1 Silicone mat "Feuille de chêne" of 10 prints 6,3 x 4,1 cm - Th. 1,5 mm



 **NEW** 098402
1 Silicone mat "Flocon givré" of 6 prints ø 8,8 cm - Th. 1,5 mm



 **NEW** 098403
1 Silicone mat "Flocon Arctique" of 5 prints ø 10,1 cm - Th. 1,5 mm



 **NEW** 098404
1 Silicone mat "Flocon polaire" of 8 prints ø 7,2 cm - Th. 1,5 mm



 **NEW** 098405
1 Silicone mat "Plumes" of 6 prints 6 designs ± 4,1 x 9,9 cm - Th. 1,5 mm



 **NEW** 098406
1 Silicone mat "Feuille" of 10 prints 3,7 x 6,4 cm - Th. 1,5 mm



KING'S CAKE STENCILS

Create original King's cakes with our new stencils!

To use them, simply place your dough on the stencil and put it in the oven!
As soon as it comes out of the oven, turn it over, remove the stencil and cover with a thin layer of caramel powder.
Put it back in the oven briefly to get a beautiful golden glaze that will really make your pattern stand out: Now, it's ready!

You can, of course, customize your stencils as you wish - just contact us for more information!

We use premium silicone made in France, suitable for contact with food.

Temperature range: -70°C/+200°C



 **NEW** 098389

1 Stencil for King's cake "Tourbillon"
for 1 piece ø 22 cm
(Usable for King's cake from ø 16 cm)



 **NEW** 098390

1 Stencil for King's cake "Pithiviers"
for 1 piece ø 22 cm
(Usable for King's cake from ø 16 cm)



 **NEW** 098386

1 Stencil for King's cake "Envol"
for 1 piece ø 22 cm
(Usable for King's cake from ø 16 cm)



 **NEW** 098387

1 Stencil for King's cake "Bubble"
for 1 piece ø 22 cm
(Usable for King's cake from ø 16 cm)



 **NEW** 098388

1 Stencil for King's cake "Rosace"
for 1 piece ø 22 cm
(Usable for King's cake from ø 16 cm)



 **NEW** 098385

1 Stencil for King's cake "Le roi"
for 1 piece ø 22 cm
(Usable for King's cake from ø 16 cm)



STENCILS

Let your creativity run wild with our new range of silicone stencils!

Ideal for both pastry-making and cooking, these flexible stencils will enable you to enhance your plaque bases and desserts by creating original and elegant decorations.

Stencils can be customized. Please contact us for more information.

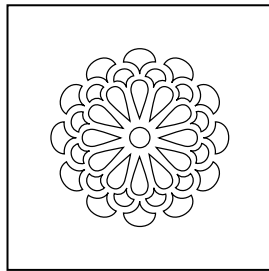

NEW 098391
 1 Stencil "Bouquet" for 1 piece
 15 x 15 cm -Th. : 1,5 mm
 Pattern size: ø 10 cm

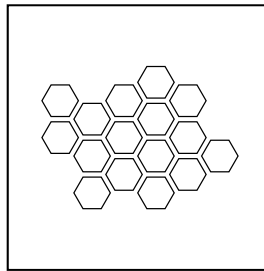

NEW 098392
 1 Stencil "Alvéoles" for 1 piece
 15 x 15 cm -Th. : 1,5 mm
 Pattern size: ± 11 x 8 cm

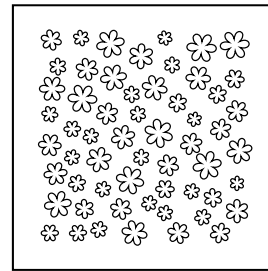

NEW 098393
 1 Stencil "Fleurettes" for 1 piece
 15 x 15 cm -Th. : 1,5 mm
 Pattern size: ± 12 x 12 cm

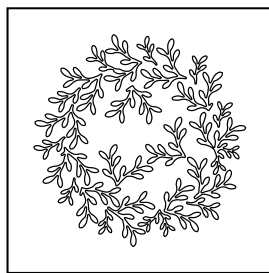

NEW 098394
 1 Stencil "Feuillage" for 1 piece
 15 x 15 cm -Th. : 1,5 mm
 Pattern size: ± 12 x 12 cm

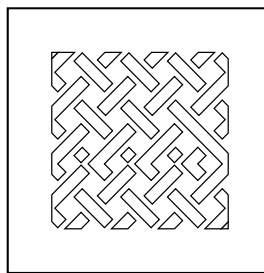

NEW 098395
 1 Stencil "Mosaïque" for 1 piece
 15 x 15 cm -Th. : 1,5 mm
 Pattern size: ± 10 x 10 cm

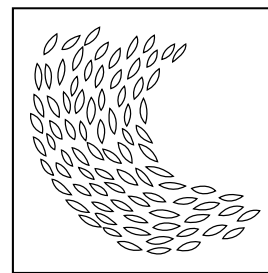

NEW 098396
 1 Stencil "Envolée" for 1 piece
 15 x 15 cm -Th. : 1,5 mm
 Pattern size: ± 12,9 x 12,8 cm

STENCILS & SILICONE MOULDS FOR CHOCOLATE DECORATIONS



SILICONE MOULDS

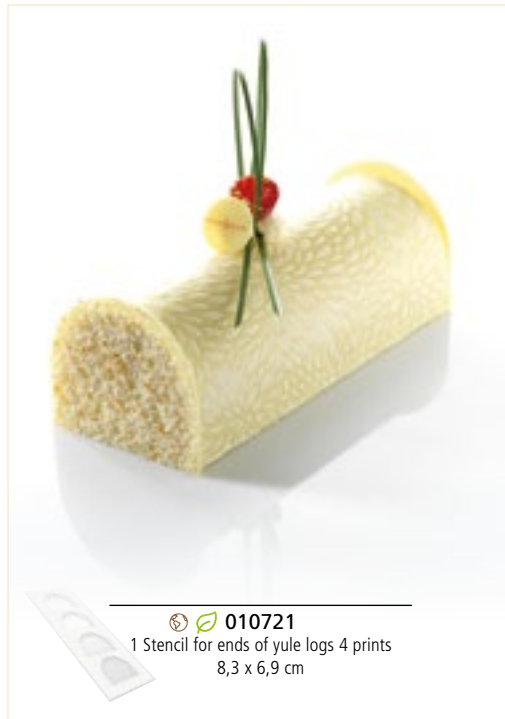

SILICONE MOULDS

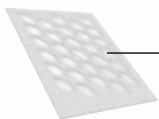

010738
1 Stencil for leaves
30 prints 7 x 3 cm



010690
1 Stencil for rectangles
15 prints 7 x 1,5 cm

010691
1 Stencil for rectangles
20 prints 7 x 2 cm



010704
1 Stencil for squares
24 prints 2 cm

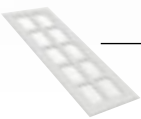

010692
1 Stencil for rectangles
10 prints 6 x 4 cm

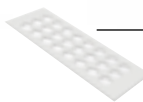

040021
1 Stencil for rounds
24 prints ø 3 cm

MARC
Rivière



010706
1 Stencil for rounds ø 2 cm, ø 2,7 cm
and ø 3,4 cm 117 prints

SILICONE MOULDS

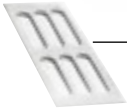

🕒 010700
1 Stencil for eclairs
6 prints 13,2 x 3,2 cm

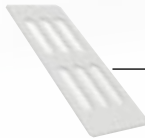

🕒 030068
1 Stencil for thin eclairs
6 prints 12 x 2,6 cm



🕒 019153
1 Stencil for rabbits 4 prints
5,3 x 13,5 cm Th. 0,3 mm



🕒 010166
1 Silicone mould "4 mains avec bras courts"

CHRISTOPHE
Michalak



🕒 009908
1 Silicone mould "Les cordelettes"
3 designs 50 cm

FRANÇOIS
Galtier



🕒 010225
4 Silicone moulds "Montre" 4 designs
Dial: ø 16 cm - Great gear: ø 14 cm
Necklace: ø 16 cm
Winder: ø 4,5 cm

🕒 010226
1 Silicone mould "Engrenages"
9 designs - 9 Gears between
ø 2 and ø 4 cm



TEARABLE MOULDS

Since 2021, our range has also included tear-off dessert moulds with either classic or more daring designs.

These moulds are ideal for protecting your desserts when stored in the freezer.
Simply pull the tab to tear the mould open and remove your dessert from the mould.

ROUNDED SQUARES

4 CM

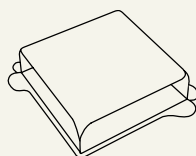

🌱 070564
100 Entremets moulds
"Carré plat arrondi"
for 100 pieces
14 x 14 cm - H. 4 cm
Tearable moulds

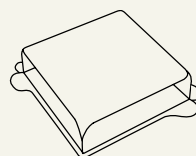

🌱 070565
100 Entremets moulds
"Carré plat arrondi"
for 100 pieces
16 x 16 cm - H. 4 cm
Tearable moulds

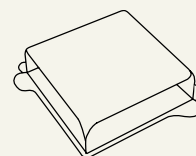

🌱 070566
100 Entremets moulds
"Carré plat arrondi"
for 100 pieces
18 x 18 cm - H. 4 cm
Tearable moulds

THE + OF TEARABLE MOULDS

- AFFORDABLE
- SUITABLE FOR FREEZING
- EASY TO REMOVE FROM THE MOULD
- MADE IN FRANCE

CLASSIC ROUNDS



4 CM

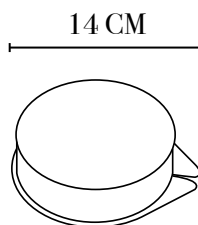

🌱 070552
100 Entremets moulds
"Rond plat" for 100 pieces
ø 14 cm - H. 4 cm
Tearable moulds

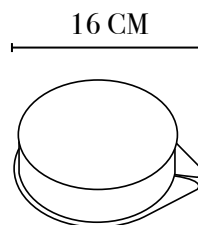

🌱 070553
100 Entremets moulds
"Rond plat" for 100 pieces
ø 16 cm - H. 4 cm
Tearable moulds

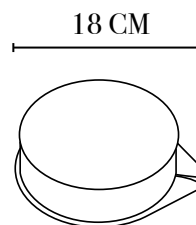

🌱 070554
100 Entremets moulds
"Rond plat" for 100 pieces
ø 18 cm - H. 4 cm
Tearable moulds

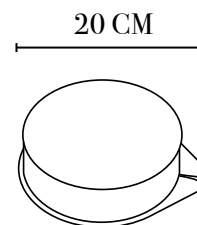

🌱 070555
100 Entremets moulds
"Rond plat" for 100 pieces
ø 20 cm - H. 4 cm
Tearable moulds

4,5 CM

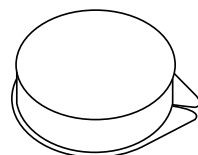

🌱 070556
100 Entremets moulds
"Rond plat" for 100 pieces
ø 14 cm - H. 4,5 cm
Tearable moulds

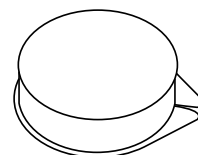

🌱 070557
100 Entremets moulds
"Rond plat" for 100 pieces
ø 16 cm - H. 4,5 cm
Tearable moulds

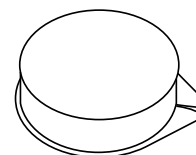

🌱 070558
100 Entremets moulds
"Rond plat" for 100 pieces
ø 18 cm - H. 4,5 cm
Tearable moulds

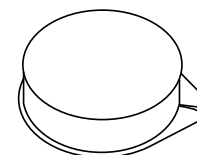

🌱 070559
100 Entremets moulds
"Rond plat" for 100 pieces
ø 20 cm - H. 4,5 cm
Tearable moulds

ROUNDED ROUNDS

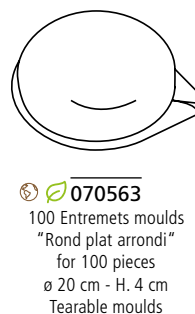
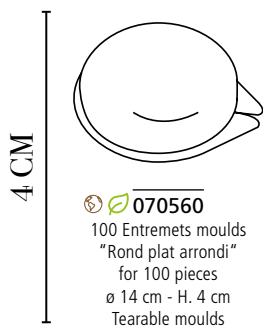
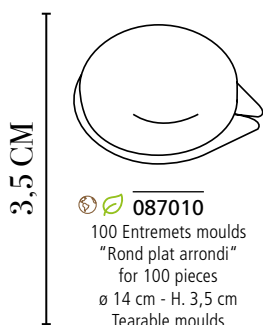
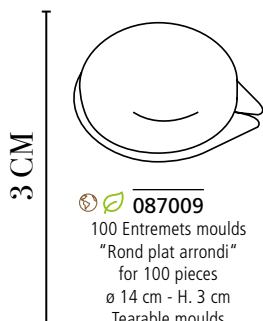

ROUNDED EGGS

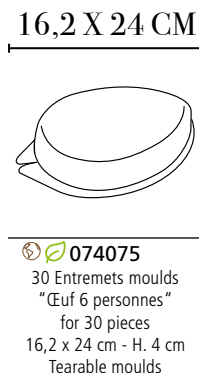
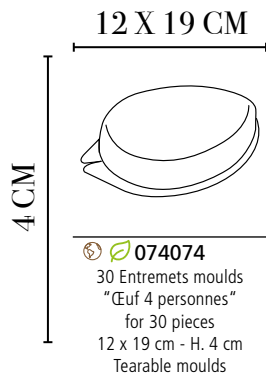

ROUNDED HEART

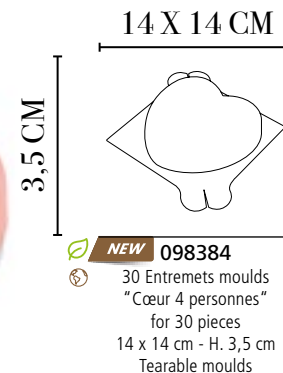

TART TOPS

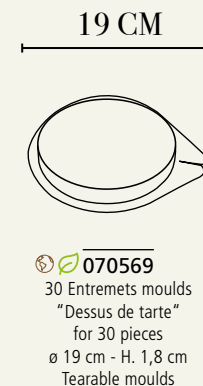

ENVELOPE

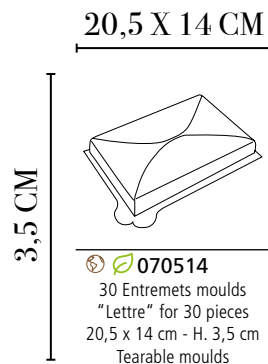

SPIRAL

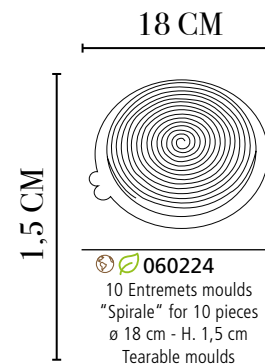

INDIVIDUAL ENTREMETS MOULDS

Reusable and freezable,

these moulds allow you to remove your desserts with ease.

We have in fact designed a "support jamb" around most of our reusable moulds which you can pour hot water into in order to remove your desserts more easily.

As such, your desserts will be easy to remove from the mould.

Our range includes individual moulds, dessert moulds and yule log moulds.

In search of exclusivity?

Our team is at your service to offer you a customised solution that best matches your needs.

Do not hesitate to contact us to discuss your customised projects.



🍷 🌿 070546
30 Entremets moulds
"Charlotte" for 120 pieces
8 x 8,3 cm - H. 3,2 cm
Moulds with support jams

THIERRY
Mulhaupt



🍷 🌿 010354
1 Tray for individual entremets "Ronds"
for 45 pieces ø 6 cm - H. 4 cm
🍷 🌿 005000
200 Rhodoïde sheets neutral 19,5 x 4 cm

PASCAL

Molines



🍷 🌿 009790
10 Molines tubes 58 cm - ø 3,5 cm and 20 covers
100 Rhodoïde sheets neutral 58 x 12 cm
🍷 🌿 005002
100 Rhodoïde sheets neutral 58 x 12 cm

SÉBASTIEN

Bouillet



🍷 🌿 009941
10 Entremets tubes "Sucettes" ø 3,5 cm - H. 8 cm
🍷 🌿 005013
200 Rhodoïde sheets neutral 12 x 8 cm
🍷 🌿 004568
200 Flat beech sticks 9,3 x 1,8 cm

ENTREMETS MOULDS



🌿 074060

30 Entremets moulds "Petite tarte rose"
for 120 pieces ø 7,4 cm - H. 2 cm

🌿 070536

30 Entremets moulds "Palet"
for 150 pieces ø 8 cm - H. 1,7 cm
Moulds with support jambs



🌿 074059

30 Entremets moulds "Petite tarte fleur"
for 120 pieces ø 7,4 cm - H. 1,7 cm
Moulds with support jambs

🌿 070536

30 Entremets moulds "Palet"
for 150 pieces ø 8 cm - H. 1,7 cm
Moulds with support jambs



🌿 070520

30 Entremets moulds "Petite tarte"
for 120 pieces ø 7,4 cm - H. 1,7 cm
Moulds with support jambs

🌿 070536

30 Entremets moulds "Palet"
for 150 pieces ø 8 cm - H. 1,7 cm
Moulds with support jambs



🌿 070535

30 Entremets moulds "Petite tarte pochage"
for 120 pieces ø 7,4 cm - H. 2,3 cm
Moulds with support jambs

🌿 070536

30 Entremets moulds "Palet"
for 150 pieces ø 8 cm - H. 1,7 cm
Moulds with support jambs

YANN

Brys



🌿 060221

16 Entremets moulds "Spirale"
for 48 pieces ø 8 cm - H. 1,5 cm

🌿 070536

30 Entremets moulds "Palet"
for 150 pieces ø 8 cm - H. 1,7 cm
Moulds with support jambs





🌿 070534



30 Entremets moulds "Petite tarte meringuée"
for 120 pieces ø 7,4 cm - H. 2,7 cm
Moulds with support jambs

🌿 070536

30 Entremets moulds "Palet"
for 150 pieces ø 8 cm - H. 1,7 cm
Moulds with support jambs

  **088188**

30 Entremets moulds "Noisette 4 personnes"
for 30 pieces 14 x 14,5 cm - H. 4 cm
Moulds with support jams

  **088189**

30 Entremets moulds "Noisette 6 personnes"
for 30 pieces 17 x 18 cm - H. 4 cm
Moulds with support jams



ENTREMETS MOULDS

CAMILLE

Lesecq



🌱 070517

30 Entremets moulds "Souche"
for 30 pieces ø 18 cm - H. 4 cm
Moulds with support jams

VINCENT

Guerlais



🌱 087061

60 Entremets moulds
"Panama" for 30 pieces
Top: 12,7 x 15 cm - H. 7 cm
Moulds with support jams
Bottom: 21 x 21 cm - H. 1,3 cm
Moulds with support jams



🌱 070513

30 Entremets moulds "St Honoré"
for 30 pieces ø 16 cm - H. 6 cm

JÉRÉMY

Del Val



🌱 074236

30 Entremets moulds "Candy"
for 30 pieces ø 17 cm - H. 4 cm
Moulds with support jams



🌿 074072
10 Entremets moulds
"Cadre Pâtissier" for
10 pieces 57 x 37 cm
H. 3,5 cm

🌿 070584
10 Entremets moulds
"Cadre Pâtissier" for
10 pieces 57 x 37 cm
H. 4 cm

🌿 074073
10 Entremets moulds
"Cadre Pâtissier" for
10 pieces 57 x 37 cm
H. 4,5 cm

ENTREMETS MOULDS

JOFFREY

Lafontaine



🌿 070521

30 Entremets moulds "Vrille"
for 30 pieces ø 17 cm - H. 9,5 cm
Moulds with support jambs

🌿 070542

30 Entremets moulds "Vrille"
for 30 pieces ø 14 cm - H. 7 cm
Moulds with support jambs

JÉRÔME

De Oliveira



🌿 070541

30 Moules "Rose" (top)
for 30 pieces ø 15 cm - H. 1,2 cm
Moulds with support jambs

CHRISTOPHE

Michalak



🌿 070537

30 Entremets moulds "Rosace"
for 30 pieces ø 15 cm - H. 1,5 cm
Moulds with support jambs



🌿 088248

30 Entremets moulds "Ourson"
for 30 pieces 13,1 x 22,3 cm - H. 6,65 cm
Moulds with support jambs



🌿 070518

30 Entremets moulds
"Demi-sphère" for 30 pieces
ø 14 cm - H. 7 cm
Moulds with support jambs

🌿 070522

30 Entremets moulds
"Demi-sphère" for 30 pieces
ø 18 cm - H. 9 cm
Moulds with support jambs

STRUCTURE SHEETS FOR ENTREMETS

These structure sheets have been specially created to be used with our moulds "Cadre pâtissier" (070584-074072-074073 P. 256) and yule log moulds "Gouttière" (070587 P. 107).



SEE INSTRUCTIONS ON OUR WEBSITE



 **009891**
10 Structure sheets "Petit Matelassé"
56,5 x 36,5 cm

 **060156**
10 Structure sheets "Petit Matelassé"
for yule log 52,7 x 17,7 cm

JÉRÔME

De Oliveira



 **074289**
10 Structure sheets "Fleurs" 56,5 x 36,5 cm

ENTREMETS

PASCAL
Niau



🍷 🌿 **010294**
10 Structure sheets "Rondin"
56,5 x 36,5 cm



🍷 🌿 **009808**
10 Structure sheets "Matelassé"
56,5 x 36,5 cm



🍷 🌿 **009836**
10 Structure sheets
"Mouvance"
56,5 x 36,5 cm

🍷 🌿 **060153**
10 Structure sheets
"Mouvance" for yule
log 52,7 x 17,7 cm



🍷 🌿 **060888**
10 Structure sheets "Feuillage" 56,5 x 36,5 cm



🍷 🌿 **009741**
10 Structure sheets "Ondulé" 56,5 x 36,5 cm



🍷 🌿 **065067**
10 Structure sheets
"Ecorce" for yule log
52,7 x 17,7 cm

🍷 🌿 **074351**
10 Structure sheets
"Ecorce"
56,5 x 36,5 cm



🍷 🌿 **036161**
10 Structure sheets
"Déstructuré"
56,5 x 36,5 cm

🍷 🌿 **060152**
10 Structure sheets
"Déstructuré" for yule
log 52,7 x 17,7 cm



🍷 🌿 **060889**
10 Structure sheets
"Envol" 56,5 x 36,5 cm

🍷 🌿 **065066**
10 Structure sheets
"Envol" for yule log
52,7 x 17,7

ANTHONY
Terrone



🍷 🌿 **000368**
10 Structure sheets
"Ananas"
56,5 x 36,5 cm

🍷 🌿 **060154**
10 Structure sheets
"Ananas" for yule log
52,7 x 17,7 cm

TRANSFER SHEETS FOR ENTREMETS



SEE INSTRUCTIONS
ON OUR WEBSITE



This entremets was made with the structure sheets "Écorce" 074351 (p. 259)



087192

20 Transfer sheets "Rondin" for entremets 26 x 26 cm N/A: USA, China, South Korea

CHOCOLATE STRIPS

These chocolate strips can be used like the classic rolls. All you need to do is surround the inside of your mould with this strip and fill in your cream desserts as usual, to obtain an ideal decoration with an incredible thinness.

PASCAL

Niau



061401

15 Chocolate strips "Fraises" - 66 x 4 cm - N/A: China, Japan

TRANSFER SHEETS FOR YULE LOG



060127

25 Transfer sheets "Rayures" for yule log 52,7 x 17,7 cm
N/A: China, Taiwan



060125

25 Transfer sheets "Taiga" for yule log 52,7 x 17,7 cm
N/A: USA, China, Japan, UAE, Saudi Arabia, Qatar, Kuwait, Bahrain, Oman,
South Korea, Singapore



060126

25 Transfer sheets "Acidulée" for yule log 52,7 x 17,7 cm
N/A: USA, China, Singapore

BAKING PAPER



070221
20 Baking paper sheets "Faux bois" 60 x 40 cm



061400
20 Baking paper sheets "Marbré" 60 x 40 cm



070222
20 Baking paper sheets "Savane" 60 x 40 cm
N/A: China, Taiwan

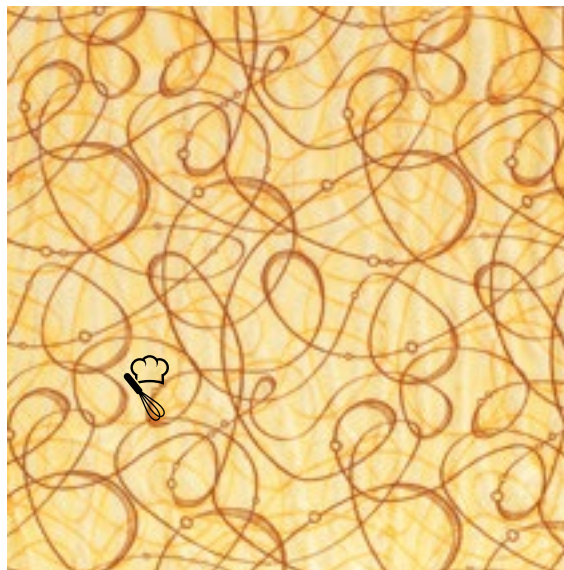

060129
20 Baking paper sheets "Poursuite" 60 x 40 cm
N/A: USA, China, Japan, South Korea

Free of colouring Worldwide • Azo



In order to obtain an even more fabulous result, we have created a compound: "Sublimasse" which once hydrated, will be applied over the baking sheet prior to your biscuit. This product prevents the appearance of air bubbles on the surface of your biscuit and also allows your biscuit to be more airy.

**SEE INSTRUCTIONS
ON OUR WEBSITE**



010384
Sublimasse nature - 900 g
N/A: USA, Canada, Japan, UAE,
Saudi Arabia, Qatar, Kuwait,
Bahrain, Oman, South Korea,
Taiwan, Singapore,



HK

INGREDIUM RANGE

The INGREDIUM range consists of four product categories:

Texturisers, Acids & Salts, Emulsifiers & Stabilisers and Sugars & Derivatives.

INGREDIUM represents a wide range of solutions carefully selected and formulated by our Research & Development team, in close collaboration with Chefs and pastry Chefs, to meet your needs and open up an infinite universe of creation.

Explore endlessly, use and abuse this new range to bring to life your most breathtaking creations!



In order to provide you with the best possible support, we place our skills and state-of-the-art equipment at your disposal to develop or adapt your recipes with products from the INGREDIUM range. **Contact our customer service (+33 (0)3 88 587 333) who will direct you to the team dedicated to this personalised service.**



Flash this QR code and find the whole range, and our recommendations for use.
Or go directly to our website: <https://www.pcb-creation.com/nos-collections/ingredium/>



Plant-based origin

Product made with plant-based raw materials.



Ingredient declaration

Product without additives that can be declared as an ingredient.



TEXTURIZERS

Bring all your creations to life and create different textures with our technical ingredients for **jellifying, thickening and stabilising**.

FIBERS: replace additives without compromising taste thanks to the jellifying, thickening and stabilising properties of these plant-based ingredients.



☑ **NATUR LIN** (Linseed vegetable fiber powder)
 ☑ **087084** - 200 g
 ☑ **074347** - 900 g



☑ **NATUR AGRUM** (Citrus fiber powder)
 ☑ **087083** - 200 g
 ☑ **074348** - 500 g



☑ **NATUR ALG** (Gracilaria seaweed powder)
087088 - 200 g
 N/A: USA, Japan, South Korea



NEW ☑ **NATUR AGRUM +** (Instant citrus fiber powder)
 ☑ **098263** - 300 g

The “additive-free” alternative for instant cold thickening (e.g. fruit Tuile biscuits, fruit cream, etc.)...

NEW!

PROTEINS: replace liquid egg white, the setting properties of whole eggs or gluten.



ALBUMEN (Pasteurised egg albumen powder)
074349 - 400 g
 N/A: USA



☑ **NATUR AIR** (Potato protein powder)
 ☑ **087082** - 200 g
 ☑ **074346** - 400 g



☑ **NATUR EGGLESS** (Starch and protein-based powder preparation)
088204 - 900 g
 N/A: Hong Kong



NEW ☑ **NATUR FIX** (Golden flax seed powder deoiled)
 ☑ **098262** - 400 g

The “additive-free” alternative for gluten-free preparations and as a binder for doughs (e.g. gluten-free madeleines).

NEW!





PROBLEMATIC	SOLUTION	EXAMPLES
REPLACE EGG WHITE	NATUR AIR	PLANT-BASED MACAROONS
REPLACE LE GLUTEN	NATUR FIX	GLUTEN-FREE MADELEINES
REPLACE JELLIFYING ADDITIVES (AGAR, PECTINE, CARRAGEENANS)	NATUR ALG	FRUIT PASTE WITHOUT ADDITIVES
REPLACE GELATINE WITH A PLANT-BASED INGREDIENT	NATUR ALG	PLANT-BASED MOUSSE
REPLACE THICKENING AND STABILISING ADDITIVES (FREEZING)	NATUR LIN	COLD SAUCE WITHOUT ADDITIVES
REPLACE TEXTURIZING ADDITIVES (MODIFIED STARCH, PECTIN)	NATUR AGRUM, NATUR AGRUM +	FRUIT "CRÈMEUX" WITHOUT ADDITIVES
REPLACE ADDITIVES TO STABILISE FROZEN DESSERTS	NATUR AGRUM + NATUR LIN	ADDITIVE-FREE ICE CREAM
REPLACE WHOLE EGGS WHILE RETAINING THEIR COAGULATIVE PROPERTIES	NATUR EGGLESS	EGG-FREE FLAN

GELATINS: thanks to their jellifying properties, they can be used in all your preparations and come from a range of animal origin (fish, pork or beef).



INGREDIUM



☑ **GELATIN F**
(Fish gelatin)
060641 - 1 kg
087089 - 12 Kg



☑ **GELATIN B**
(Bovine gelatin)
060642 - 1 kg
087090 - 12 Kg
N/A: UAE, Saudi Arabia,
Qatar, Kuwait, Bahrain, Oman



☑ **GELATIN P**
(Pig gelatin)
060648 - 1 kg
087091 - 12 Kg
N/A: USA, Canada, UAE, Saudi
Arabia, Qatar, Kuwait,
Barhain, Oman



☑ **GELATIN FAST**
(Instant bovine gelatin powder)
087087 - 500 g
N/A: Canada, UAE, Saudi Arabia, Qatar,
Kuwait, Bahrain, Oman

Time-saving gelatin:
it can be applied directly to the preparation without being heated or pre-hydrated

PECTINS: whether for acidic, sweet or calcium-rich preparations, each of our pectins will suit your creations.



☑ **PECTINE YELLOW**
(Pectins)
060626 - 1 kg
N/A: China, Japan, Taiwan



☑ **PECTINE CA** (Pectins)
060628 - 1 kg
N/A: Japan



☑ **PECTINE NHX** (Pectins)
060627 - 1 kg
N/A: China, Japan

Pectin for a variety of uses:
toppings,
mousses,
creams, fruity
inserts, etc.

STARCHES: for quick and easy thickening, hot or cold.



☑ **COLDTEX**
(Modified potato starch)
060632 - 1 kg
N/A: USA



☑ **WARMTEX**
(Corn starch)
060636 - 800 g
N/A: USA



☑ **COLDTEX+**
(Modified tapioca starch)
060616 - 500 g
N/A: USA, Canada

Instant cold thickener
for fruit or
plant-based
purées



Plant-based



Ingredient declaration

INGREDIUM



ALGAE, GUM AND METHYLCELLULOSE DERIVATIVES:

a wide variety of thickening agents of plant-based origin to choose from depending on the desired texture and use.



 **AGAR** (Agar)
060643 - 700 g
N/A: Japan, South Korea, Taiwan



 **ALGINAT**
(Sodium alginate)
 088264 - 200 G
060629 - 1 kg





KAPPA (Carrageenan)
060630 - 800 g
N/A: Japan



 **IOTA** (Carrageenan)
060631 - 1 kg
N/A: Japan



 **ACACIA**
(Acacia gum)
 060614 - 500 g



XANTHAN
(Xanthan gum)
087079 - 200 g
060615 - 1 kg
N/A: Japan



 **CAROUBE**
(Locust bean gum)
065306 - 800 g
N/A: Japan



 **GUAR** (Guar gum)
060622 - 1 kg
N/A: Japan



GELLAN (Gellan gum)
087080 - 200 g
060635 - 700 g
N/A: Japan



 **METHYL-GEL**
(Methylcellulose)
060623 - 400 g

ACIDS & SALTS

Their acidifying, antioxidant, mineralising and acidity-modulating properties will provide that little extra needed to **jellify** certain texturising agents or allow you to **subtly balance the flavour profile** of your creations.



 **CITRIX** (Citric acid)
060620 - 1 kg



 **ASCORBIX**
(Ascorbic acid)
060621 - 1 kg



 **CALCIUM LA**
(Calcium lactate)
060639 - 750 g
N/A: USA, China



 **SODIUM CI**
(Sodium citrates)
060640 - 1 kg
N/A: USA



BAKING POWDER
(Baking powder)
088268 - 1 kg
088290 - 5 kg
N/A: USA, Canada

Phosphate-free
baking powder

EMULSIFIERS & STABILIZERS

Emulsifying and stabilising properties will optimise storage-life and stabilise your preparations and frozen desserts.

EMULSIFIERS: to emulsify according to the base of use (aqueous or fatty) and according to your plant-based origin preferences (soya or sunflower).



 **EMUL A**
(Sunflower lecithin)
060645 - 600 g
N/A: USA



 **EMUL S** (Soy lecithin)
087081 - 200 g
060649 - 600 g
N/A: USA

A **must-have** for **emulsifying** ganaches or caramels or for creating those last-minute mousses.

STABILISERS: optimise the texture and conservation of your ice creams and sorbets to ensure optimum quality during tasting.



 **SORBIUM** (Blend of sorbet stabilizers)
061391 - 800 g N/A: Japan

A combination of texturizers to improve the **stabilisation, whipping, melting speed and texture** of sorbets



ICREMIUM (Blend of ice cream texturizers)
061392 - 800 g N/A: Japan, Taiwan

A combination of texturizers to improve the **stabilisation, whipping, melting speed and texture** of ice creams



SUGARS & DERIVATIVES

Their diverse sweetening, structuring and colouring properties when cooked, which allows you to diversify your recipes and **reduce their sugar** content while **preserving the richness of taste** and aroma of your sweet creations.

TECHNICAL SUGARS:



- ☑ **DEXTROSE** (Dextrose)
- ☑ **060618** - 1 kg
- ☑ **087093** - 10 Kg



- ☑ **GLUCOSE P**
- ☑ (Dried glucose syrup)
- ☑ **060633** - 1 kg
- ☑ **087094** - 10 Kg
- N/A: USA



- ☑ **NEIGE DECOR**
- ☑ (Powder preparation for pastry decoration)
- ☑ **088269** - 800 g
- ☑ **088270** - 5 Kg
- N/A: USA, Canada, Japan, Hong Kong

Moisture-resistant powdered sugar.
Free from palm oil and additives.

MUST-HAVE!



- ☑ **MALTO** (Maltodextrin)
- ☑ **060617** - 600 g
- ☑ **087092** - 9 Kg



- ☑ **MALTO DRY**
- ☑ (Tapioca maltodextrin)
- ☑ **060619** - 500 g
- N/A: USA

POLYOLS:



- ☑ **MALTITOL** (Maltitol)
- ☑ **060625** - 1 kg
- N/A: USA, Japan, Hong Kong



- ☑ **SORBITOL** (Sorbitol)
- ☑ **060624** - 1 kg
- ☑ **087096** - 12 Kg
- N/A: USA, China, Hong Kong



- ☑ **ISOMALT** (Isomalt)
- ☑ **060647** - 1 kg
- ☑ **004488** - 5 kg
- ☑ **087097** - 15 kg
- N/A: Japan, Hong Kong



- ☑ **INULIN** (Inulin)
- ☑ **060637** - 800 g
- ☑ **087095** - 10 Kg
- N/A: China



- ☑ **NATUR SWEET**
- ☑ (Dietary fiber (fructooligofructose))
- ☑ **088203** - 900 g



- ☑ **TREHALOSE**
- ☑ (Trehalose)
- ☑ **NEW 098399** - 1 Kg
- ☑ **NEW 098400** - 14 Kg

FIBERS:

SCALE OF SWEETENING POWER

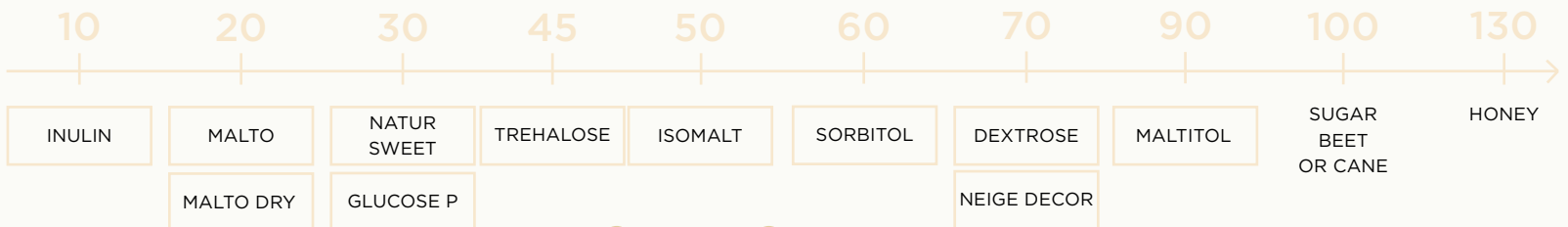

Plant-based



Ingredient declaration



UNDERSTANDING COLOUR

Colouring: how does it work?

Discover through this table the multiple coloring possibilities offered by the products of our range, and their specificities.

	POWDERS & 100% FRUIT/ VEGETABLE PIECES	COLOURING FOODSTUFF	NATURAL DYES	SYNTHETIC DYES
DESCRIPTION	"Natural" colouring solutions extracted from vegetable, mineral or animal sources use transformation processes which respect the original raw material and result in rather significant concentrations of pigment.			Concentrated food colouring derived from pigments produced by synthesis and purification. These pigments can not usually be found in nature.
	Materials produced as a result of a simple physical transformation (freeze-drying, grinding) of fruit and vegetables.	Materials produced by non-selective extraction from fruit, vegetables or plants.	Materials produced by selective extraction from vegetable, mineral or animal sources.	
TASTE*	Typical taste	Slight taste possible	Little taste	No taste
COLOUR INTENSITY**	Light	Medium intensity	Intense to very intense	Intense to very intense
DECLARATION STATEMENT***	No additives (Ingredient)	No additive (Food colouring: ingredient)	Additive E Number present in colouring	Additive E Number present in colouring
LIMITED QUANTITY***	No (except for use with chocolate)	No (except for use with chocolate)	Yes	Yes
POSSIBLE USES***	Chocolate with fruit Marshmallows Fondant Icing / Icing Velvet cakes Cream	Glazing & Decoration Fondant Icing/ Icing Biscuit Velvet cakes Meringues Macaroons	Icing Velvet cakes Macaroons	Icing Velvet cakes Macaroons

*Taste: variable depending on the product and the amount used.

**Colour: variable depending on the product and the amount used.

***The declaration statement, quantity limits and possible uses depend on the regulations in force in the country of marketing and/or export and sometimes have no direct link with the natural qualities of the material in question. It is therefore very important to double check these aspects when creating your recipe.



Some colorants may be subject to dosage limitations or bans depending on the final application (EU Regulations 1129/2011, 380/2012, and 1333/2008). Therefore, it is the responsibility of the user to ensure that the use of the colorant complies with the applicable regulations. Please feel free to contact our customer service for any further clarification.



100% FRUIT/VEGETAL POWDERS



Use the QR code to discover our tips for use and the maximum doses authorized:



 **045003**
Mango powder - 200 g



 **050226**
Passion fruit powder - 200 g
N/A: Japan



 **045004**
Barley grass powder (gluten free)
200 g - N/A: USA



 **045000**
Strawberry powder - 200 g
N/A: Taiwan



 **045001**
Raspberry powder - 200 g



 **074338**
Hibiscus powder - 200 g - N/A: USA



 **045002**
Blackcurrant powder - 200 g
N/A: USA



 **060646**
Matcha powder - 200 g
N/A: USA



 **065302**
Black cocoa powder - 200 g
N/A: USA

FAT SOLUBLE POWDERS

Procedure:

melt the cocoa butter, add some colouring powder and mix with a brush. With this base, you can colour your products.

This mixture can be stored: all you need is to melt it before using it again.

For your chocolate gun:

mix 50% of dark chocolate and 50% of cocoa butter. Add the colouring powder.



COLORING POWDERS

COLOURING FOODSTUFF

Watersoluble &
Fat-soluble powders



BLUE (spirulina)
 050118 - 50 g
Upon request:
050723 - 200 g
050724 - 1 Kg



GREEN TURF
(carthame, lemon and spirulina) - *N/A: USA, China*
060571 - 50 g
Upon request:
054145 - 200 g
054146 - 1 Kg



LIGHT GREEN
(carthame, lemon and spirulina) - *N/A: USA, China*
060572 - 50 g
Upon request:
054147 - 200 g
054148 - 1 Kg



YELLOW (safflower, lemon) - *N/A: USA, China*
050080 - 50 g
Upon request:
049991 - 200 g
050719 - 1 Kg



ORANGE (carthame, lemon paste and radish, blackcurrant and apple)
N/A: USA, China
060573 - 50 g
Upon request:
053940 - 200 g
054140 - 1 Kg



054394
 Colour chart "Easycolor" for colouring foodstuff



PINK* (red beetroot juice)
 050081 - 50 g
Upon request:
050721 - 200 g
050722 - 1 Kg



PURPLE (carrot, hibiscus)
N/A: USA
065301 - 50 g
Upon request:
068114 - 200 g
068847 - 1 Kg



BRIGHT RED (radish, blackcurrant, apple)
 050079 - 50 g
Upon request:
049990 - 200 g
050720 - 1 Kg

NATURAL COLOURS

Natural fat-soluble powders



NATURAL PINK
(E120) *N/A: China, Japan*
004612 - 25 g
Upon request:
004401 - 200 g
001848 - 1 Kg



NATURAL BLACK
(E153) *N/A: USA, South Korea*
004604 - 25 g
Upon request:
006723 - 200 g
018110 - 1 Kg



NATURAL PURPLE
(E163) *N/A: China*
004658 - 50 g
Upon request:
004415 - 200 g
002178 - 1 Kg



NATURAL GREEN
(E141) *N/A: USA, Canada, Japan, South Korea, Taiwan*
004657 - 50 g
Upon request:
004410 - 200 g
018113 - 1 Kg



NATURAL YELLOW
(E100)
065311 - 25 g
Upon request:
064164 - 200 g
069332 - 1 Kg



NATURAL ORANGE
(E100, E163)
N/A: Singapore
065259 - 25 g
Upon request:
064763 - 200 g
069335 - 1 Kg

SYNTHETIC COLOURS

Fat-soluble powders



GREEN • (E102, E133)
N/A: UAE, Saudi Arabia, Qatar, Kuwait, Bahrain, Oman, South Korea, Taiwan, Hong Kong, Singapore
004463 - 25 g
Upon request:
005065 - 200 g
001877 - 1 Kg



ORANGE • (E110)
N/A: UAE, Saudi Arabia, Qatar, Kuwait, Bahrain, Oman
004464 - 25 g
Upon request:
005046 - 200 g
017845 - 1 Kg



RED • (E129) *N/A: UAE, Saudi Arabia, Qatar, Kuwait, Bahrain, Oman*
004462 - 25 g
Upon request:
004214 - 200 g
003018 - 1 Kg



BLUE (E132)
004460 - 25 g
Upon request:
004230 - 200 g
002190 - 1 Kg



YELLOW • (E102)
N/A: UAE, Saudi Arabia, Qatar, Kuwait, Bahrain, Oman, South Korea, Taiwan, Hong Kong, Singapore
004461 - 25 g
Upon request:
004217 - 200 g
005084 - 1 Kg



WHITE (E171) - *N/A: UAE, Saudi Arabia, Qatar, Kuwait, Bahrain, Oman*
004459 - 50 g
Upon request:
004142 - 200 g
001873 - 1 Kg

Free of colouring Worldwide • Azo

*To use of this reference in white chocolate, we recommend the use of a hand blender to obtain a homogeneous result.

WATER SOLUBLE POWDERS

These colouring can also be used with airbrush. Process: dissolve in boiling water or alcohol.



COLORING POWDERS

COLOURING
FOODSTUFF

Water-soluble powders



RED (radish, blackcurrant, apple and paprika extract)
 070266 - 50 g
 Upon request:
 071868 - 200 g
 073064 - 1 Kg



PURPLE (carrot, hibiscus)
 N/A: USA
 065301 - 50 g
 Upon request:
 068114 - 200 g
 068847 - 1 Kg



BLUE (spirulina)
 050118 - 50 g
 Upon request:
 050723 - 200 g
 050724 - 1 Kg



GREEN TURF (carthame, lemon and spirulina)
 N/A: USA, China
 060571 - 50 g
 Upon request:
 054145 - 200 g
 054146 - 1 Kg



LIGHT GREEN (carthame, lemon and spirulina)
 N/A: USA, China
 060572 - 50 g
 Upon request:
 054147 - 200 g
 054148 - 1 Kg



ORANGE (paprika extract)
 070269 - 50 g
 Upon request:
 073063 - 200 g
 072435 - 1 Kg



BRIGHT RED (radish, blackcurrant, apple)
 050079 - 50 g
 Upon request:
 049990 - 200 g
 050720 - 1 Kg



YELLOW (safflower, lemon)
 N/A: USA, China
 050080 - 50 g
 Upon request:
 049991 - 200 g
 050719 - 1 Kg



ORANGE (carthame, lemon paste and radish, blackcurrant and apple) - N/A: USA, China
 060573 - 50 g
 Upon request:
 053940 - 200 g
 054140 - 1 Kg



PINK (red beetroot juice)
 050081 - 50 g
 Upon request:
 050721 - 200 g
 050722 - 1 Kg



BROWN (malt extract)
 060576 - 50 g N/A: USA
 Upon request:
 054142 - 200 g
 054141 - 1 Kg

NATURAL
COLOURS

Natural water-soluble powders



NATURAL CARAMEL (E150A)
 004661 - 25 g
 Upon request:
 023662 - 200 g
 045157 - 1 Kg



NATURAL GREEN (E141) N/A: USA, Canada, Japan, South Korea, Taiwan
 004662 - 25 g
 Upon request:
 029552 - 200 g
 049858 - 1 Kg



NATURAL YELLOW (E160A)
 004659 - 25 g
 Upon request:
 023661 - 200 g
 025869 - 1 Kg



NATURAL RED (E120)
 N/A: China, Japan
 004660 - 15 g
 Upon request:
 029551 - 200 g
 018687 - 1 Kg



NATURAL INTENSE RED (E162)
 N/A: Hong Kong
 088215 - 15 g

SYNTHETIC
COLOURS

Water-soluble powders



YELLOW • (E102*) N/A: USA, UAE, Saudi Arabia, Qatar, Kuwait, Bahrain, Oman, South Korea, Taiwan, Hong Kong, Singapore
 004535 - 15 g
 Upon request:
 023295 - 200 g
 018727 - 1 Kg



BLUE (E133)
 004536 - 15 g
 Upon request:
 023660 - 200 g
 018728 - 1 Kg



RED • (E129*) N/A: USA, UAE, Saudi Arabia, Qatar, Kuwait, Bahrain, Oman
 004534 - 15 g
 Upon request:
 009241 - 200 g
 018725 - 1 Kg



CREATE YOUR OWN COLORS
MIXING THE PRIMARY HUES
(RED, YELLOW AND BLUE)

SHINY COLOURS

This food colouring will make all your products shine and give them an incredible spark.

You have various possibilities:

In powder:

- spread it with your finger
 - sprinkle it on the chocolate
 - sprinkle some powder over a nylon sheet
- Scrub with your finger and place the dipped chocolate bonbons over the sheets.

By diluting with alcohol:
apply it with a brush.



SHINY COLOURS IN POT

COLORING POWDERS



SHINY COLOUR "RUBY RED" (E172) N/A: USA, China, Japan, South Korea, Singapore
025196 - 10 g
 Upon request:
029678 - 200 g
029747 - 1 Kg



SHINY COLOUR GLITTER EFFECT "RUBY" (E172) N/A: USA, China, Japan, Qatar, South Korea, Singapore
004670 - 25 g
 Upon request:
004409 - 200 g
018119 - 1 Kg



SHINY COLOUR "RUBY" (E172) N/A: USA, China, Japan, Qatar, South Korea, Singapore
004485 - 15 g
 Upon request:
007527 - 200 g
009144 - 1 Kg



SHINY COLOUR "BRONZE" (E172) N/A: USA, China, Japan, Qatar, South Korea, Singapore
004483 - 15 g
 Upon request:
002247 - 200 g
002276 - 1 Kg



SHINY COLOUR "COPPER" (E172) N/A: USA, China, Japan, Qatar, South Korea, Singapore
004484 - 15 g
 Upon request:
011962 - 200 g
001485 - 1 Kg



SHINY COLOUR GLITTER EFFECT "SILVER" (E171) N/A: China, Japan, UAE, Saudi Arabia, Qatar, Kuwait, Bahrain, Oman, South Korea, Singapore
004676 - 15 g
 Upon request:
001730 - 200 g
003410 - 1 Kg



SHINY COLOUR GLITTER EFFECT "GOLD" (E171, E172) N/A: USA, China, Japan, UAE, Saudi Arabia, Qatar, Kuwait, Bahrain, Oman, South Korea, Singapore
004669 - 25 g
 Upon request:
001782 - 200 g
002741 - 1 Kg



SHINY COLOUR "GOLD" (E171, E172) N/A: USA, China, Japan, UAE, Saudi Arabia, Qatar, Kuwait, Bahrain, Oman, South Korea, Singapore
004481 - 15 g
 Upon request:
001452 - 200 g
001169 - 1 Kg



SHINY COLOUR "SILVER" (E171) N/A: China, Japan, UAE, Saudi Arabia, Qatar, Kuwait, Bahrain, Oman, South Korea, Singapore
004482 - 15 g
 Upon request:
002211 - 200 g
001184 - 1 Kg



SHINY COLOUR "AMETHYST" (E132, E171, E172) N/A: USA, China, Japan, UAE, Saudi Arabia, Qatar, Kuwait, Bahrain, Oman, South Korea, Singapore
004552 - 15 g
 Upon request:
015952 - 200 g
073066 - 1 Kg



SHINY COLOUR "RED" (E129*, E120, E171, E172) N/A: USA, China, Japan, UAE, Saudi Arabia, Qatar, Kuwait, Bahrain, Oman, South Korea, Singapore
004576 - 15 g •
 Upon request:
001196 - 200 g •
018118 - 1 Kg •



SHINY COLOUR "IRIDESCENT PINK" (E171) N/A: China, Japan, UAE, Saudi Arabia, Qatar, Kuwait, Bahrain, Oman, South Korea, Singapore
004525 - 15 g
 Upon request:
010490 - 200 g
005405 - 1 Kg



SHINY COLOUR "IRIDESCENT BLUE" (E171) N/A: China, Japan, UAE, Saudi Arabia, Qatar, Kuwait, Bahrain, Oman, South Korea, Singapore
004526 - 15 g
 Upon request:
022540 - 200 g
018114 - 1 Kg



SHINY COLOUR "IRIDESCENT GOLD" (E171) N/A: China, Japan, UAE, Saudi Arabia, Qatar, Kuwait, Bahrain, Oman, South Korea, Singapore
004533 - 15 g
 Upon request:
022541 - 200 g
018115 - 1 Kg



SHINY COLOUR "EMERALD" (E100, E133, E171, E172) N/A: USA, China, Japan, UAE, Saudi Arabia, Qatar, Kuwait, Bahrain, Oman, South Korea, Singapore
004479 - 15 g
 Upon request:
001767 - 200 g
002175 - 1 Kg



SHINY COLOUR "AMBER" (E120, E171, E172, E100) N/A: USA, China, Japan, UAE, Saudi Arabia, Qatar, Kuwait, Bahrain, Oman, South Korea, Singapore
004486 - 15 g
 Upon request:
004150 - 200 g
008113 - 1 Kg



SHINY COLOUR "SAPPHIRE" (E132, E171) N/A: China, Japan, UAE, Saudi Arabia, Qatar, Kuwait, Bahrain, Oman, South Korea, Singapore
004480 - 15 g
 Upon request:
006848 - 200 g
013303 - 1 Kg

SHINY COLOURS IN SPRAY FORMAT

Add a delightful dash of shiny magic to any and all of your creations. Available in 4 magical shades: add to your desserts, ice creams, chocolate candies, and tier cakes. Follow your creative heart!



040170
 1 Shiny powder spray Glitter effect "Silver" - 10 g (E171)
 N/A: China, Japan, UAE, Saudi Arabia, Qatar, Kuwait, Bahrain, Oman, South Korea, Singapore



040172
 1 Shiny powder spray Glitter effect "Gold" - 10 g (E171, E172)
 N/A: USA, China, Japan, UAE, Saudi Arabia, Qatar, Kuwait, Bahrain, Oman, South Korea, Singapore



040171
 1 Shiny powder spray Glitter effect "Ruby" - 10 g (E172)
 N/A: USA, China, Japan, Qatar, South Korea, Singapore



060568
 1 Shiny powder spray Glitter effect "Bronze" - 10 g (E172)
 N/A: USA, China, Japan, Qatar, South Korea, Singapore



100% FRUIT/VEGETAL COCOA BUTTER

We've created a range of fruity cocoa butters especially for you, made from cocoa butter and freeze-dried fruit/plant powders, 100% natural, without colourings; to make a velvet effect using a spray gun or just as they are to naturally add colour to all your creations. Used in velvet on your entremets, these cocoa butters richer in fruit and fiber than a classic cocoa butter (up to 30%) are therefore less brittle, and bring more elasticity for creations with perfect visual and holding. They also bring a touch of fruity taste, a real plus to a classic cocoa butter.



NEW 089431
Cocoa butter in pistoles 10 Kg
(Upon request) - N/A: USA

100% FRUIT/VEGETAL COCOA BUTTERS



045008
Strawberry Cocoa butter
200 g - N/A: Taiwan



045009
Raspberry Cocoa butter
200 g



074337
Hibiscus Cocoa butter
200 g - N/A: USA



045011
Mango Cocoa butter
200 g



050227
Mango Strawberry
Cocoa butter - 200 g
N/A: Taiwan



045012
Barley grass Cocoa
butter - 200 g



088198
Cocoa butter Light cocoa
200 g



045013
Cocoa butter Brown
cocoa - 200 g



045014
Cocoa butter Amber
cocoa - 200 g



045015
Cocoa butter Black
cocoa - 200 g



065304
White "Flocking" - 200 g
065305
White "Flocking" - 800 g



074172
Extra White Cocoa butter
200 g



DISCOVER OUR "COLOUR" CATALOGUE:

Many recipes and application ideas, and a non-exhaustive selection of nuances that you can create with our fruit powders, and fruit/vegetal cocoa butters.



Make your work easier with these ready-to-use coloured cocoa butters which will assure you a perfect colouring. You can use this product in many different ways: with a brush, with a spray (gun, airbrush ...) in order to colour your chocolate, to tint your creams...

COLORED COCOA BUTTERS

COLOURING FOODSTUFF COCOA BUTTERS

Colored cocoa butters - 200 g



 **050076**
Orange (radish, apple, blackcurrant, safflower)
N/A: USA, China

 **050077**
Yellow (safflower, lemon)
N/A: USA, China

 **060580**
Light green (spirulina and carthame)
N/A: USA, China

 **050078**
Green (spirulina, safflower)
N/A: USA, China

 **050073**
 Blue (spirulina)







OTHER PACKAGING OPTIONS ARE AVAILABLE UPON REQUEST

CONTACT-US!



 **065303**
Purple (carrot, hibiscus)
N/A: USA

 **050074**
 Red (radish, apple, blackcurrant)

 **050075**
 Pink (red beetroot juice)

 **088199**
Caramel color (safflower, lemon and cocoa) 200 g
N/A: USA, China

 **054394**
Colour chart "Easycolor" for colouring foodstuff



NATURAL COCOA BUTTERS

Colored cocoa butters - 200 g



004611
Black (E153)
N/A: USA, China, South Korea

004656
Green (E141)
N/A: USA, Canada, Japan, South Korea, Taiwan

004609
Red (E120)
N/A: China, Japan

004655
Purple (E163)
N/A: China

065295
Orange color (E100, E163) N/A: China, Singapore

 **065312**
Egg yolk color (E100)

NEW 098348
White (E170 (nano))
200 g - N/A: USA

 Free of colouring  Worldwide • Azo





CREATE YOUR OWN COLORS
MIXING THE PRIMARY HUES
(RED, YELLOW AND BLUE)

CLASSICS

CLASSIC COCOA BUTTERS

Colored cocoa butters - 200 g



004457

Pistachio green color •
(E133) N/A: UAE, Saudi
Arabia, Qatar, Kuwait, Bahrain,
Oman, South Korea, Taiwan,
Hong Kong, Singapore



004456

Strawberry red color •
(E129) N/A: UAE, Saudi
Arabia, Qatar, Kuwait, Bahrain,
Oman



004572

Black color (E172)
N/A: USA, China, Japan,
South Korea



004458

Orange color • (E110*)
N/A: UAE, Saudi Arabia,
Kuwait, Qatar, Bahrain, Oman



004453

White (E171)
N/A: UAE, Saudi Arabia,
Qatar, Kuwait, Bahrain, Oman



004470

Raspberry red color •
(E122*) N/A: USA, Canada,
Japan, UAE, Saudi Arabia,
Qatar, Kuwait, Bahrain, Oman,
South Korea, Taiwan



004454

Blueberry blue color
(E132)



004469

Egg yolk color • (E102*)
N/A: UAE, Saudi Arabia,
Qatar, Kuwait, Bahrain, Oman,
South Korea, Taiwan, Hong
Kong, Singapore



004455

Lemon yellow color •
(E104*) N/A: USA, Canada,
China, Japan, UAE, Saudi
Arabia, Qatar, Kuwait, Bahrain,
Oman, South Korea, Taiwan



004627

Purple (E120, E133,
E171) N/A: China, Japan,
UAE, Saudi Arabia, Qatar,
Kuwait, Bahrain, Oman



OTHER PACKAGING OPTIONS ARE AVAILABLE UPON REQUEST
CONTACT-US!

SHINY

SHINY COCOA BUTTERS

Colored cocoa butters - 200 g



004614

Shiny gold (E171, E172)
N/A: USA, China, Japan,
South Korea, UAE, Saudi
Arabia, Qatar, Kuwait, Bahrain,
Oman, Singapore



004616

Shiny bronze (E172)
N/A: USA, China, Japan,
Qatar, South Korea,
Singapore



004600

Shiny ruby (E172)
N/A: USA, China, Japan,
Qatar, South Korea,
Singapore



004601

Shiny copper (E172)
N/A: USA, China, Japan,
Qatar, South Korea,
Singapore



004566

Iridescent pink • (E171,
E124*) N/A: USA, Canada,
China, Japan, UAE, Saudi Arabia,
Qatar, Kuwait, Bahrain, Oman,
South Korea, Singapore



004615

Shiny silver (E171)
N/A: China, Japan, UAE,
Saudi Arabia, Qatar, Kuwait,
Bahrain, Oman, South Korea,
Singapore

Free of colouring Worldwide • Azo



VELVET SPRAYS

These sprays make it possible to give a **velvet effect** on your frozen desserts or entremets:
We developed an exclusive new formula: no need to be put in drying oven, our new sprays can be **used at ambient temperature**.
 Let your creativity run wild: underline the "relief" of your dessert, draw using a stencil key set... **You are an artist!**

METHOD OF USE:

Keep the product at room temperature (20-25°C/ 68-77°F) for at least 2 hours before use. Shake well before use.
 Spray an even layer of product on a cold surface from a distance of 20-25 cm.
 After use, turn the spray can upside down and spray for a few seconds to clean the dispenser. Store at room temperature*

*If the product has been stored at a temperature <20°C/ 68°F, place in a bain-marie or oven (35°C/95°F) for around 20 minutes to liquefy the product before use.



 **074339**
 Velvet spray "Dark
 chocolate" - 500 ml
 N/A: China, UAE, Saudi
 Arabia, Qatar, Kuwait,
 Bahrain, Oman

 **074340**
 Velvet spray "White"
 500 ml
 N/A: China, UAE, Saudi
 Arabia, Qatar, Kuwait,
 Bahrain, Oman

 **074345**
 Velvet spray "Yellow"
 500 ml
 N/A: USA, China, UAE,
 Saudi Arabia, Qatar, Kuwait,
 Bahrain, Oman

 **074344**
 Velvet spray "Green"
 500 ml
 N/A: USA, China, UAE,
 Saudi Arabia, Qatar, Kuwait,
 Bahrain, Oman

 **074343**
 Velvet spray "Orange"
 500 ml
 N/A: USA, China, UAE,
 Saudi Arabia, Qatar, Kuwait,
 Bahrain, Oman

 **074342**
 Velvet spray "Pink"
 500 ml
 N/A: China, UAE, Saudi
 Arabia, Qatar, Kuwait,
 Bahrain, Oman

 **074341**
 Velvet spray "Red"
 500 ml
 N/A: China, UAE, Saudi
 Arabia, Qatar, Kuwait,
 Bahrain, Oman





THE TWO PRODUCTS BELOW CAN BE USED FOR GLAZING, FINISHING AND PROTECTING CHOCOLATE COATED SUGAR CONFECTIONERY.



070268 is a glazing solution based on gum arabic which is used to gloss the sugar-coated confectionery and should be applied first. 061076 is a shellac based glazing solution that provides a protective layer against moisture and air and should be applied last.

- The surface of the chocolate coated centers must be completely solidified before applying the finishing solutions

- The air blower for drying the dragees following application of the finishing solutions must comply with the following characteristics

- maximum 45-50% relative humidity
- 10-12°C for white chocolate, 12-14°C for milk chocolate and 16-18°C for dark chocolate



061076

Varnish pearly for chocolate moulding - 200 g
N/A: China, Japan, UAE, Saudi Arabia, Qatar, Kuwait, Bahrain, Oman

070268

Coating solution made of gum arabic - 1 Kg
This product must be shaken sufficiently before use because it tends to phase out.
N/A: UAE, Saudi Arabia, Qatar, Kuwait, Bahrain, Oman

A TYPICAL EXAMPLE WITH CHOCOLATE COVERED HAZELNUTS:

	PRODUCT USED	QUANTITY (mL/100Kg)	MIXING WITHOUT AIR BLOWER	DRYING WITH AIR BLOWER
1ST LAYER	070268	250 mL	1-2 min	7-10 min
2ND LAYER		150 mL		
3RD LAYER		100 mL		
LAST LAYER	061076	130-170 mL		5 min

These solutions can be applied simply by pouring the recommended amount using a measuring cup or syringe. When using a spray system, it is vital to use two separate systems for the two products as these solutions are not compatible. After these different layers have been applied, the dragees must be set aside for at least 2 hours to finalise the drying process before packing. We recommend storing them in an environment with the same atmospheric conditions as those used for glazing.



DÉCOR À MODELER

Discover our modelling décor recipe! Its new, more malleable texture allows for easy modelling, and its newly refined ingredients bring out its great white chocolate flavour. Mouldable like marzipan, you can cover your desserts and create fabulous hand-made decorations or use a pastry cutter. To be used alone or with the support of a silicone mould, you can no longer do without this magical paste!

DÉCOR À MODELER



SEE INSTRUCTIONS ON OUR WEBSITE



025197
Décor à modeler "White chocolate" - 500 g



025198
Décor à modeler "Dark chocolate" - 500 g



025205
Décor à modeler "Black" - 500 g
N/A: USA, China, South Korea



025200
Décor à modeler "Red" - 500 g - N/A: China, Japan



025201
Décor à modeler "Green" - 500 g



025202
Décor à modeler "Yellow" - 500 g



060969
Décor à modeler "Orange" - 500 g
N/A: China, Japan



025199
Décor à modeler "White" - 500 g - N/A: UAE, Saudi Arabia, Qatar, Kuwait, Bahrain, Oman



060968
Décor à modeler "Pink" - 500 g
N/A: China, Japan

Free of colouring • Worldwide • Azo



PIPETTES & TUBES TO FILL



004558
 100 Pipettes 15,5 x 1,3 cm



004575
 30 Tubes to fill - 30 ml



004640
 1 Clamp for tube

004664
 30 Tubes to fill - 15 ml

Looking for something out of the ordinary for your desserts? Something to impress your guests? Your customers will delight in using the pipettes to inject coulis into their dessert and marvel at DIY decoration with their own tube. Coulis, ganache... let your imagination run wild!

PASTRY-MAKING USTENCILS



004550
Spray topping - 500 ml

For all your products which require a shiny appearance as well as a protection against oxidation. This spray with a subtil fruity taste could be used to cover: your "petits fours", your fruits, your Joconde biscuit, your tarts by giving them a thin and regular glaze. *N/A: USA, China, Japan, UAE, Saudi Arabia, Qatar, Kuwait, Bahrain, Oman*



004499
Unmold spray - 500 ml

Spray a thin layer on your moulds before filling to make turning out a breeze. *N/A: USA, China, UAE, Saudi Arabia, Qatar, Kuwait, Bahrain, Oman*



004570
Air blower - Cooler - 335 ml
The right way up, you can use it as a cooler. Upside down, you can use it as an air blower. This product is ideal to work on your artistic creations during competitions...
N/A: USA, China

A MUST-HAVE!



010384
Sublimasse nature - 900 g

In order to obtain an even more fabulous result, we have created a compound, which once hydrated, will be applied over the baking sheet prior to your biscuit. This product prevents the appearance of air bubbles on the surface of your biscuit and also allows your biscuit to be more airy.
N/A: USA, Canada, Japan, South Korea, UAE, Saudi Arabia, Qatar, Kuwait, Bahrain, Oman, Taiwan, Singapore



004472
Edible glue - 160 g

This glue is used to stick chocolate figures on the presentation carton.
N/A: USA, UAE, Saudi Arabia, Qatar, Kuwait, Bahrain, Oman



NEW 089431
Cocoa butter in pistoles 10 Kg
(Upon request) *N/A: USA*

No more wasted icing, effort, time or energy and a streamlined process for icing your cakes thanks to this icing turntable developed by Arnaud Larher. It allows icing to be recovered via a channel directly into the pail without moving the cake or the turntable.



ARNAUD
Larher

004710
Icing turntable



007208
5 Knives



087076
10 Sparkling candles - *N/A: Hong Kong*



007196
Silicone baking net - size: 40 x 60 cm



NEUTRAL SHEETS

Those rigid sheets will allow you to make your chocolates "shine".

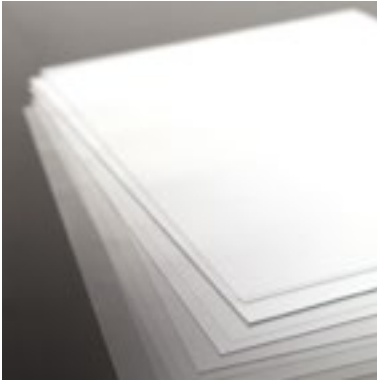

005008
25 Rhodoïde sheets size 40 x 60 cm

These supple sheets will allow you to "shine" your chocolates and to spread your ganache before cutting them up with your guitar.



005009
500 Guitare sheets size 40 x 60 cm



005012
100 Guitar sheets bundled 38 x 38 cm

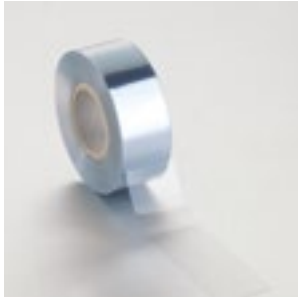

010920
1 Roll 4 cm x 50 m

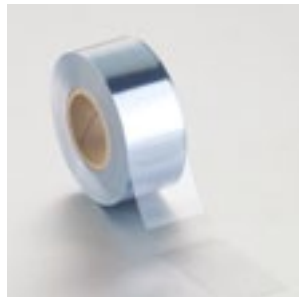

010922
1 Roll 4,5 cm x 50 m

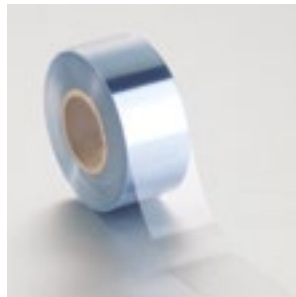

010921
1 Roll 5 cm x 50 m



010923
1 Roll 6 cm x 50 m

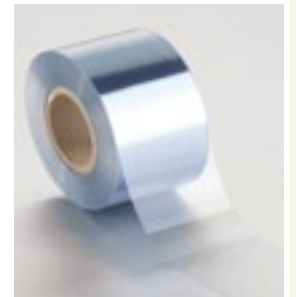

NEW 098148
1 Roll 10 cm x 50 m

This baking paper will allow you to serve sweet or savoury paper-wrapped dishes which will please your clients by their presentation. In fact, this extremely transparent paper goes directly from the oven to the serving plate. It will astonish your guests and will make them appreciate even more, this way of cooking and presentation.



004561
1 Roll 50 cm x 25 m



036133
5 White rigid plates 74 x 54 cm - Th. 2 mm

SUMMARY OF DECORATIONS | FINISHED DECORATIONS

“BISCUITÉS” DECORATIONS



“MERINGUÉS” DECORATIONS



OPALINES & CRYSTAL DECORATIONS

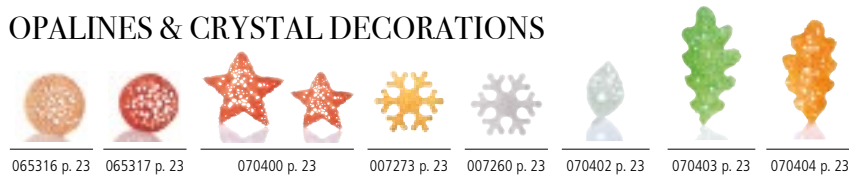

HAPPY HALLOWEEN

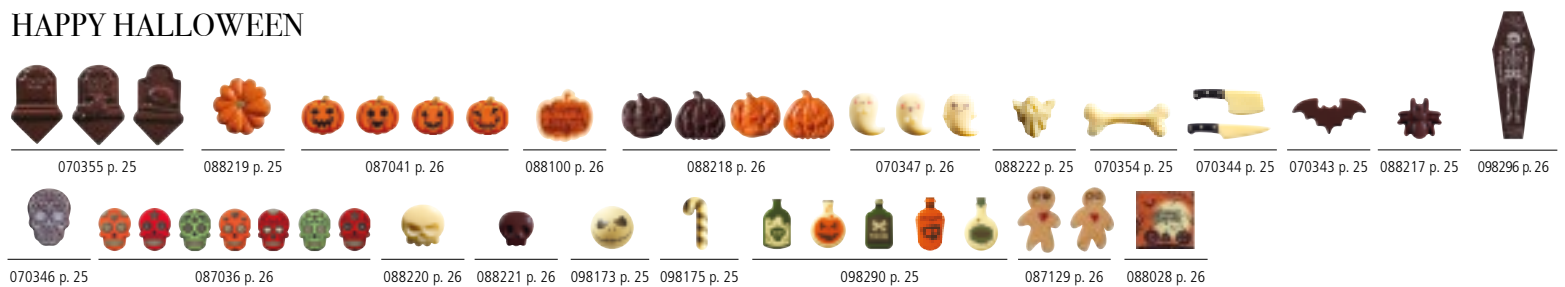

HAPPY THANKSGIVING

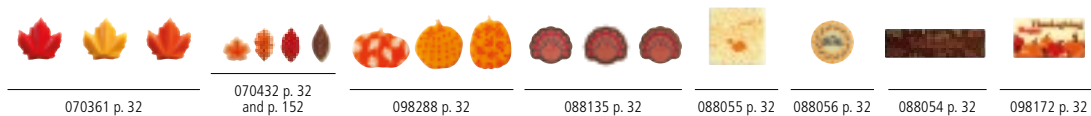

3D CHRISTMAS DECORATIONS

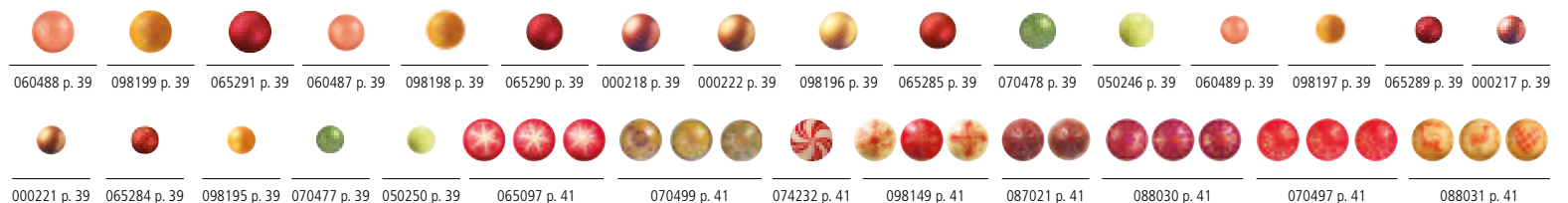

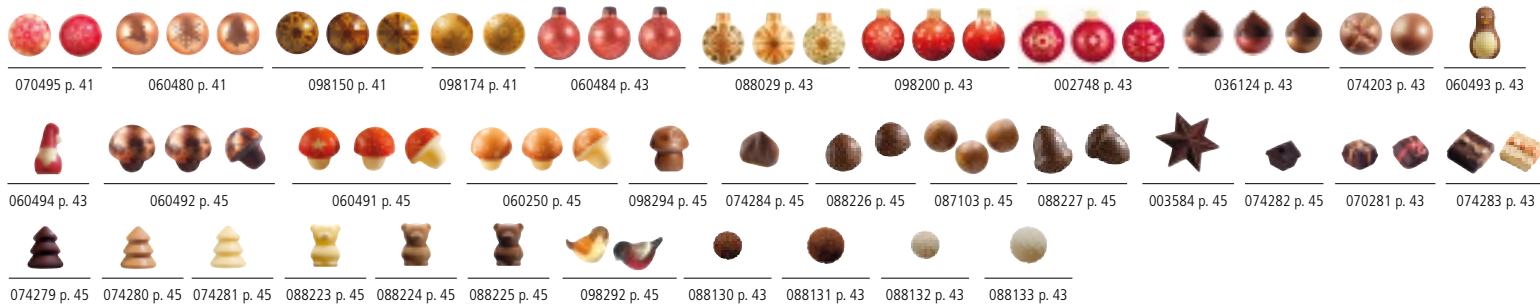

CHRISTMAS DECORATIONS



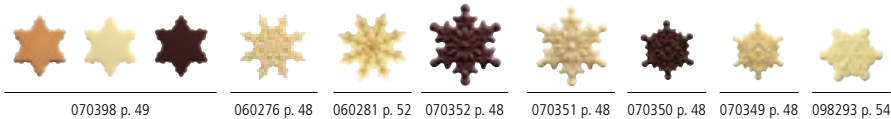

070398 p. 49 060276 p. 48 060281 p. 52 070352 p. 48 070351 p. 48 070350 p. 48 070349 p. 48 098293 p. 54

CHOCOLATE PIECES



060467 p. 65 074302 p. 65 087042 p. 65 074300 p. 65 074352 p. 65 074298 p. 65 088042 p. 65 098207 p. 65 074301 p. 65 088045 p. 65 088040 p. 65 098184 p. 65 098297 p. 65 088044 p. 65 098181 p. 65

CHOCOLATE PIECES



070464 p. 67 003300 p. 67 088046 p. 67 074296 p. 58 and p. 67 088101 p. 67 070463 p. 67 070472 p. 67 088064 p. 67 070471 p. 67 065116 p. 67

ENDS OF YULE LOG

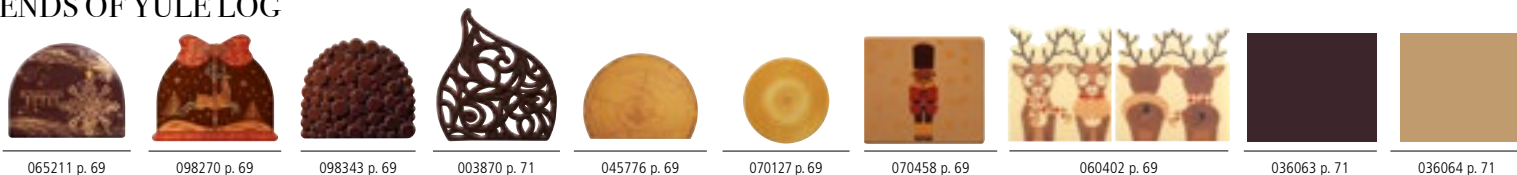

065211 p. 69 098270 p. 69 098343 p. 69 003870 p. 71 045776 p. 69 070127 p. 69 070458 p. 69 060402 p. 69 036063 p. 71 036064 p. 71



036065 p. 71 002880 p. 71 003989 p. 71 098340 p. 71 098336 p. 71 098341 p. 71

SMALL ENDS OF YULE LOG



088102 p. 73 088103 p. 73 088106 p. 73 088107 p. 73 088108 p. 73 088109 p. 73 088110 p. 73 088111 p. 73 088113 p. 73 088112 p. 73 098330 and 098331 p. 73

ECLAIR CHOCOLATE TOPPINGS



070079 p. 75 040190 p. 75 060496 p. 75 040079 p. 75

EMBOSSED PIECES

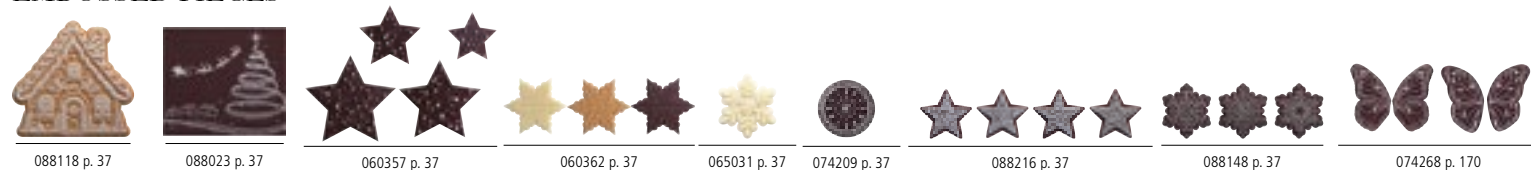

088118 p. 37 088023 p. 37 060357 p. 37 060362 p. 37 065031 p. 37 074209 p. 37 088216 p. 37 088148 p. 37 074268 p. 170



045733 p. 170 060942 p. 170 060943 p. 170 060944 p. 170 050280 p. 170 087101 p. 112 and 170

“NATURE“ DECORATIONS

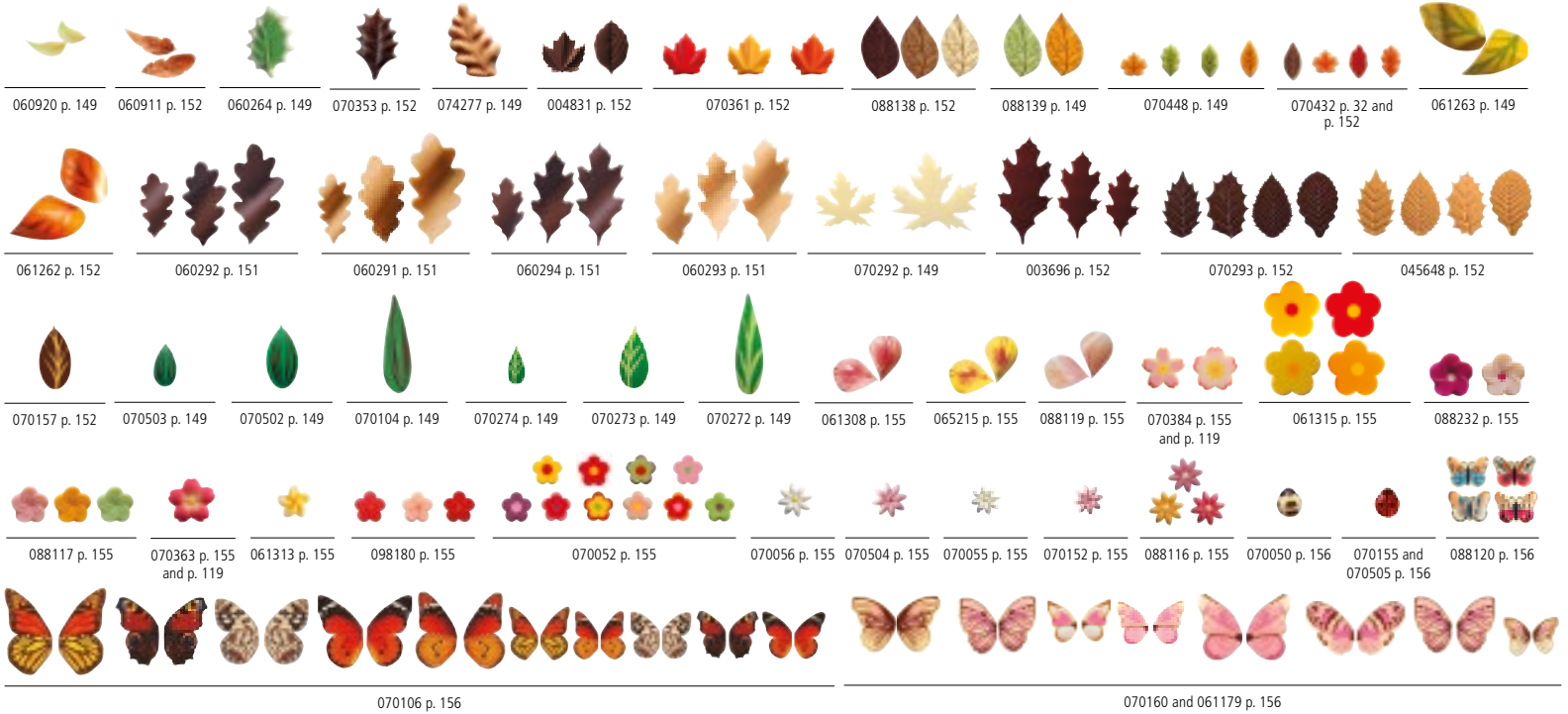

MIDDLE EAST COLLECTION

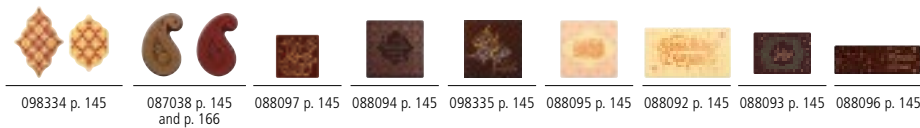

EXTRA THIN DECORATIONS

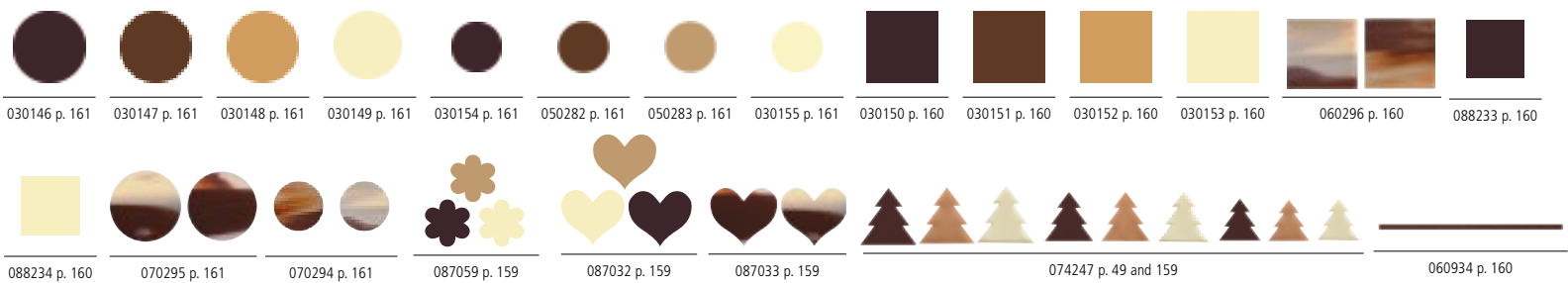

TIMELESS DECORATIONS

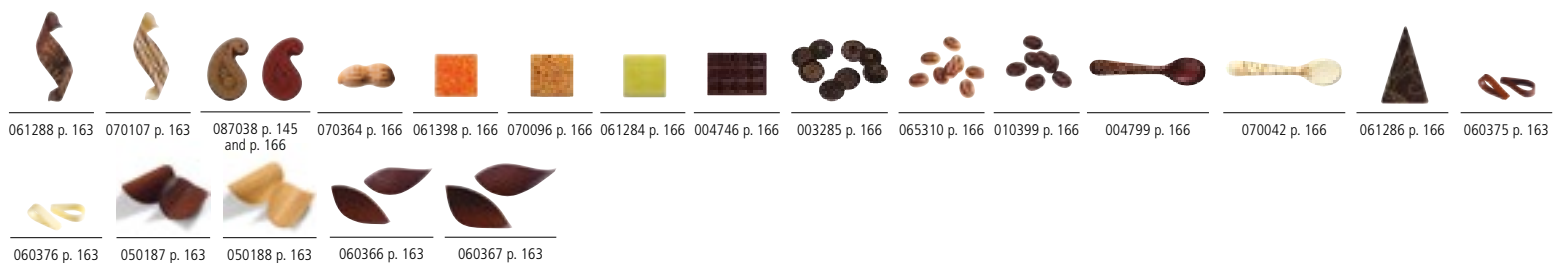

STICKS



MIXED CIRCLES

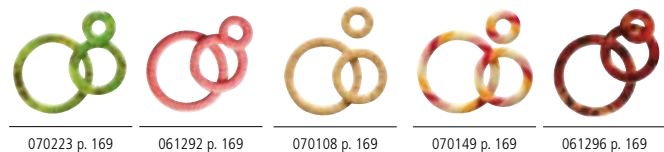

BIRTHDAY DECORATIONS

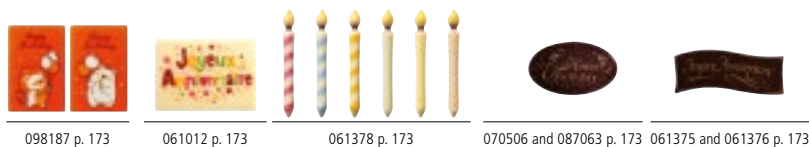

MARSHMALLOW DECORATIONS



ACCESSORIES FOR CHARACTERS



VALENTINE'S DAY

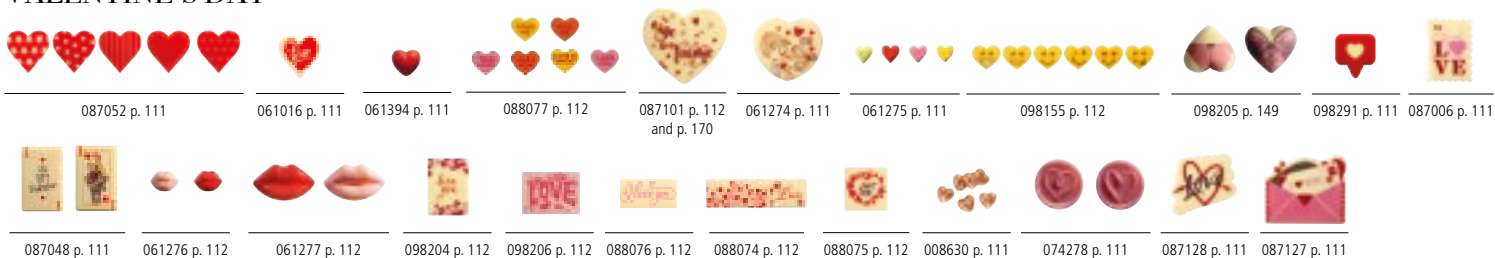

CELEBRATION DAYS PIECES



ASIAN COLLECTION



087049 p. 119 070250 p. 119 070278 p. 119 087035 p. 119 070341 p. 119 070364 p. 119 087045 p. 119 070384 p. 119 070363 p. 119 088134 p. 119 098319 p. 119

EASTER



003779 p. 121 061064 p. 121 019168 p. 121 088083 p. 121 087023 p. 121 074058 p. 121 070029 p. 121 088081 p. 121 088082 p. 121 098152 p. 121



098151 p. 121 070169 p. 126 070172 p. 126 004886 p. 126 070167 p. 126 070090 p. 122 098279 p. 126 070087 p. 122 087024 p. 126 088137 p. 126 088127 p. 122 087046 p. 125

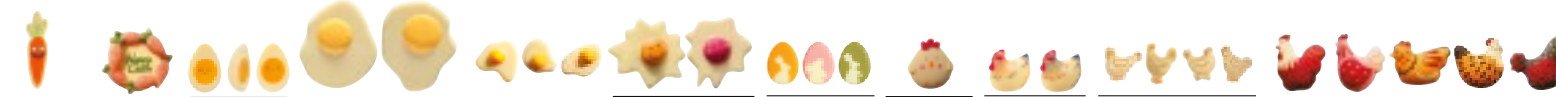

088140 p. 125 098281 p. 125 088085 p. 125 087067 p. 125 061069 p. 125 088084 p. 122 088129 p. 125 061170 p. 122 088230 p. 126 060907 p. 126 098272 p. 126



070089 p. 122 088231 p. 122 088128 p. 125 088088 p. 126 074294 p. 126 070168 p. 126 074293 p. 126



098167 p. 122 098168 p. 125 098278 p. 122

BLISTERS TO FILL

The references below refer to blisters.
All you have to do is add your own chocolate to the different moulds and voila!
You get magnificent decorations. Using these blisters couldn't be easier.

Before using: Your room and your work surface must be tempered to +22°C, to optimize the removal and demoulding of your decorations.
Printed blisters: Fill the blisters with your chocolate (be careful to keep the temperature of the chocolate at its optimum level throughout the filling process). Lightly vibrate/shake the blister pack for 15 to 20 seconds. Then land the chocolate slightly crystallise (1 minute) without moving the blister- pack. Refrigerate at 4°C for 30 minutes to 2 hours depending on the size and volume of the products. Unmould by pushing gently from underneath

Neutral blisters: Fill the blisters with your chocolate. Lightly vibrate/shake the blister pack to drive out air bubbles. Refrigerate at 4°C for 30 minutes to 1 hour depending on the size of the chocolate pieces. Unmould. Neutral blisters are reusable: you can clean them with cotton wipes. Please note that the gloss effect will decrease gradually with use.



098407 p. 115



010714 p. 49



098265 p. 60



098264 p. 173

098331 p. 73



074255 p. 66



087037 p. 67



070439 p. 74



087064 p. 63

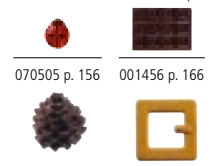

070505 p. 156

001456 p. 166

087107 p. 48

087043 p. 58

STENCILS FOR CHOCOLATE DECORATIONS



025120
1 Stencil for snowflakes 12 prints 5 x 4,3 cm
P. 245



060326
1 Stencil for saws 4 prints 15 x 5,3 cm
Th. 2 mm - P. 245

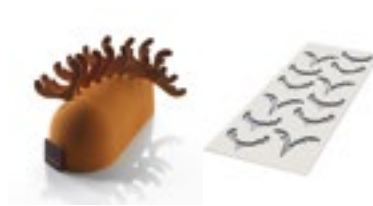

010714
1 Stencil for reindeer antlers 12 prints
3 designs 5 x 6 cm - P. 49 and 245



010745
1 Stencil for end of yule log 4 prints 9,1 x 8,2 cm
P. 245



010721
1 Stencil for end of yule log 4 prints
8,3 x 6,9 cm - P. 245



010715
1 Stencil of 4 prints for mapple leaves
2 designs 10 x 9,3 cm and 7,6 x 7 cm - P. 245



010738
1 Stencil of 30 prints for leaves 7 x 3 cm
P. 246



040021
1 Stencil for rounds 24 prints ø 3 cm - P. 246



010704
1 Stencil of 24 prints for squares 2 cm - P. 246



010692
1 Stencil de 10 prints for rectangles 6 x 4 cm
P. 246



010706
1 Stencil of 117 prints for rounds ø 2 cm,
ø 2,7 cm and ø 3,4 cm - P. 246



010690
1 Stencil of 15 prints for rectangles 7 x 1,5 cm
P. 246



019153
1 Stencil for rabbits 4 prints 5,3 x 13,5 cm
Th. 0,3 mm - P. 247



030068
1 Stencil for thin eclairs 6 prints 12 x 2,6 cm
P. 247



010700
1 Stencil for eclairs 6 prints 13,2 x 3,2 cm
P. 247

SILICONE MOULDS FOR DECORATION



009908
1 Silicone mould "Les cordelettes" 3 designs
50 cm - P. 247



010225
4 Moulds silicone "Montre" 4 designs
Dial: ø 16 cm - Great gear: ø 14 cm - Necklace: ø 16 cm
Winder: ø 4,5 cm - P. 247

010226
1 Silicone mould "Engrenages" 9 designs
9 Gears between ø 2 and ø 4 cm - P. 247



010166
1 Silicone mould "4 mains avec bras courts"
P. 247

SUMMARY OF KITS

CHOCOLATE KITS



004433 p. 81



070017 p. 81



004431 p. 81



065243 p. 81



009885 p. 81

PRINTED MOULDS



088255 p. 83

060596 p. 83



065242 p. 83



070437 p. 83



087169 p. 83



070438 p. 83



060597 p. 84



098227 p. 113



087164 p. 113



074196 p. 129



088091 p. 129



098329 p. 128

074145 p. 129



061227 p. 129



074002 p. 129



098325 p. 82



098326 p. 141

BLISTER PUZZLES



088153 p. 91



074249 p. 91



098245 p. 91



087171 p. 91



087172 p. 91



088066 p. 91



004428 p. 91

BLISTERS LOLLIPOPS



087034 p. 207

061248 p. 207

070176 p. 129

061387 p. 207



070014 p. 207

087066 p. 207

060206 p. 208

070389 p. 208

040159 p. 208



074166 p. 208

070390 p. 29

074165 p. 208

098321 p. 208



074290 p. 93

070018 p. 93

087051 p. 93

070186 p. 93



074202 p. 93

098327 p. 92

061247 p. 93

098324 p. 93

004560 p. 93, p. 207

004478 p. 93

002138 p. 93, p. 207

TRANSFER SHEETS & MOULDS FOR KITS

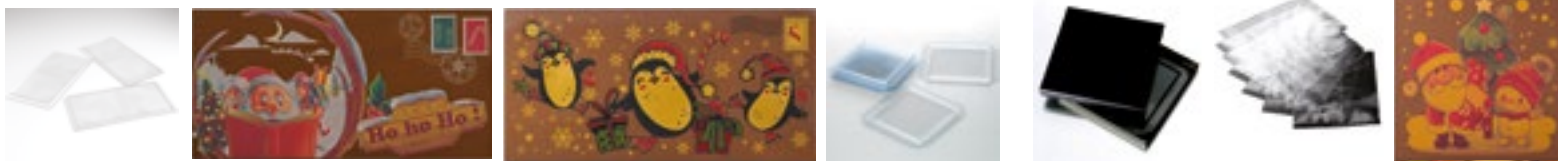

010144 p. 97

098231 p. 97

088072 p. 97

009961 p. 97

004429 p. 97

004432 p. 97

087178 p. 97



098239 p. 97

088073 p. 97

025191 p. 95, p. 113 and p. 213

087180 p. 113

088068 p. 95

087003 p. 95

098223 p. 213

070421 p. 95



009884 p. 95



070326 p. 95

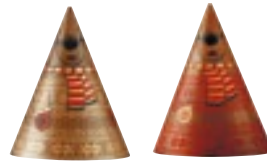

088071 p. 95



088237 p. 29 and 113



088186 p. 29

098248 p. 113



045558 p. 96



088069 p. 96



098219 p. 96



087004 p. 96



089001 p. 29



098240 p. 29



070428 p. 217



070583 p. 217



098237 p. 217



070436 p. 217



098360 p. 219



098380 p. 219



098379 p. 219



098378 p. 219



098381 p. 219



098375 p. 219



098376 p. 219



098377 p. 219



NEUTRAL MOULDS FOR TABLETTES



045564

12 Moulds "Avent" for 12 pieces 19,6 x 16,5 cm
Th. 0,7 cm - Weight: ± 220 g - P. 89



088247

12 Moulds "P'tit biscuit" for 12 pieces 11,6 x 14 cm
Th. 1,8 cm - Weight: ± 100 g - P. 89



074314

12 Moulds "Tablette horloge" for 12 pieces
ø 15,5 cm - Th. 1cm - Weight: ± 130 g - P. 89



087065

12 Moulds "Couronne de l'avent" for 12 pieces
18 x 19 cm - Th. 1,5 cm - Weight: ± 180 g - P. 89



074076

12 Moulds "Fleur" for 12 pieces ø 15 cm
Th. 1,6 cm - Weight: ± 210 g - P. 215



040150

2 Moulds "Tablette Lapins" for 8 pieces
15 x 14 cm - Th. 0,7 cm - Weight: ± 100 g - P. 133



025192

2 Moulds "Cœurs" for 8 pieces
15,5 x 6,2 cm - Weight: ± 70 g - P. 113 and P. 215



098368

10 Moulds "Tablette Pirates" for 12 pieces
ø 14 cm - Th. ± 1,5 cm - Weight: ± 140 g - P. 215



009960
2 Moulds "Zodiaque" 12 designs for 12 pieces
12 x 12 cm - Weight: ± 65 g - P. 215



098362
12 Moulds "Tablette Éléments" for 12 pieces 3 designs 15,5 x 7,5 cm
Th. ± 1,3 cm Weight: : ± 100 g - P. 214



004429
Packing boxes for square
cards - P. 97 and 215



004432
100 bags for square cards
P. 97 and 215

MARSHMALLOW MOULDS



088242
10 Marshmallow moulds "Fantôme" for
120 pieces 5,7 x 7 cm - Th. 2 cm - P. 205



088243
10 Marshmallow moulds "Ourson" for
80 pieces 5 x 8 cm - Th. 2,2 cm - P. 205



088244
10 Marshmallow moulds "Lapinou" for
80 pieces 4,3 x 8,5 cm - Th. 2,4 cm - P. 205



098357
10 Marshmallow moulds "Rudolphe" for
80 pieces 5,2 x 8,5 cm - Th. 1,77 cm - P. 205



098358
10 Marshmallow moulds "Maggy" for
80 pieces 5,15 x 7,9 cm - Th. 1,7 cm - P. 205



098359
10 Marshmallow moulds "Santa" for
80 pieces 4,7 x 8 cm - Th. 1,74 cm - P. 205

ADVENT CALENDARS



087008 p. 34



098249 p. 34



074334 p. 34



088057 p. 34



074330 p. 35



088058 p. 35

NEUTRAL MOULDS FOR KITS



070423
9 Moulds coffin "Six pieds sous terre" Bottom:
7,9 x 14,6 cm - Th. 3 cm - Cover: 7,9 x 14,6 cm
Th. 1,37 cm - Skeleton: 6,5 x 13,2 cm - Th. 0,8 cm
P. 29



074321
14 Moulds "Grimoire Halloween" for 4 pieces
10 x 13 cm - Th. 4 cm - Weight: ± 160 g - P. 29



088236
12 Moulds "Chauve-souris" for 6 pieces
10 x 14,2 cm - Th. 4,65 cm - Weight: ± 65 g
P. 29



098351
12 Moulds "Trio de citrouilles" for 6 pieces 3 designs
7,2 x 6,2 cm - H. 7,1 cm Weight: : ± 30 g - P. 28



087062
10 Moulds "Renard" for 5 pieces
8 x 13 cm - Th. 8 cm - Weight: ± 90g
P. 210

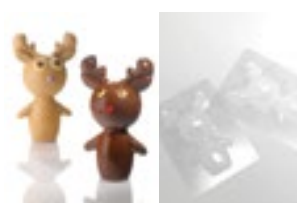

045563
20 Moulds "Renne" for 10 pieces
9 x 15 cm - Weight: ± 105 g - P. 84



060208
10 Moulds "Hiboux" for 5 pieces
10,7 x 12 cm - Th. 9,7 cm - Weight:
± 120 g - P. 210

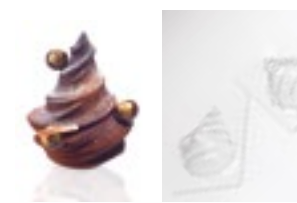

070429
10 Moulds "Sapin Poché" for 5 pieces
11,6 x 15 cm -Th. 11,8 cm - Weight:
± 100 g - P. 84



088238
8 Moulds "Sapin vrille" for 4 pieces
9,6 x 15 cm - Th. 9,5 cm - Weight: ± 70 g
P. 84



060212
9 Moulds "Mon Beau Sapin" for 3 pieces
ø 14 cm, ø 11 cm, ø 8 cm, ø 6 cm, ø 4 cm
Weight: ± 100 g - P. 84

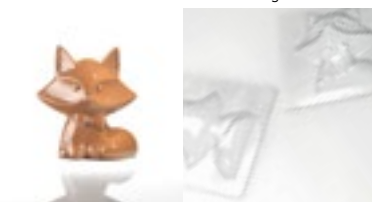

065089
10 Moulds "Renard sur son 31" pour 5 pieces
11 x 12 cm -Th. 7,65 cm - Weight: ± 120 g - P. 210

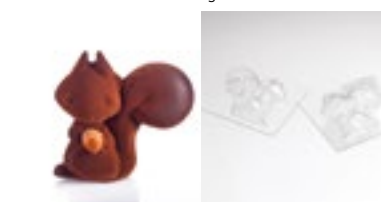

070427
8 Moulds Écureuil "Scrat" for 4 pieces
13,4 x 12,5 cm - Th. 7,5 cm - Weight: ± 100 g - P. 210

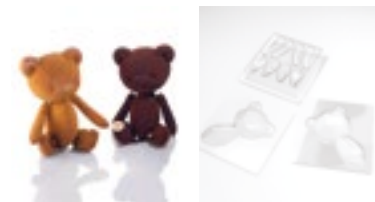

070424
12 Moulds "Teddy bear" for 4 pieces 8,6 x 13,4 cm
3,9 x 6,4 cm - 2,4 x 5 cm - Th. 6,9 cm
Weight: ± 100 g - P. 210



060209
10 Moulds "Ours frileux" for 5 pieces
9 x 15 cm - Th. 6 cm - Weight: ± 90 g - P. 87



009842
6 Moulds "Traîneau" for 2 pieces 21 x 10,5 cm
H. 13 cm - Weight: ± 300 g - P. 87



098363
8 Moulds Traîneau "Baroque" for 4 pieces
13 x 10,8 cm Th. ± 7 cm - Weight: ± 100 g - P. 88



098365
6 Moulds "Pilotes de Noël" for 6 pieces 2 designs
3,9 x 5,1 cm and 6,8 x 6,85 cm - H. ± 4 cm and 4,65 cm
Weight: ± 15 g - 20 g - P. 85

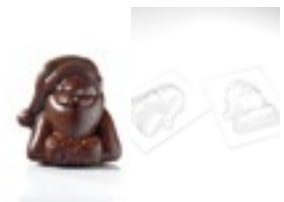

074316
12 Moulds "Père Noël Slave" for 6
pieces 12,7 x 13 cm - Th. 7,5 cm -
Weight: ± 120 g - P. 87



010208
8 Moulds "Père Noël bonnet" for
4 pieces 6 x 5,8 cm - H. 14 cm -
Weight: ± 45 g - P. 87



074311
12 Moulds "Casse Noisette" for
6 pieces 6 x 17 cm - Th. 5,2 cm -
Weight: ± 70 g - P. 87



074318
15 Moulds "Boules de Noël" for 15 pieces - 5 designs
5 x 5,8 cm - Th. 2,5 cm - Weight: ± 20 g - P. 87



098224
24 Moulds "Boules graphiques" for 12 pieces 3
designs 7,2 x 8,4 cm - Weight: : ± 100 g - P. 86



098352
10 Moulds "Œuf volutes" for 5 pieces 8,2 x 13 cm
Th. 8,3 cm - Weight: ± 85 g - P. 131



074089
12 Moulds "Œuf Mandala" for 6 pieces 10 x 15 cm
Th. 10 cm - Weight: ± 130 g - P. 130



098367
12 Moulds "Œuf pastille" for 6 pieces 10,4 x 15 cm
Th. ± 5 cm - Weight: ± 120 g - P. 133



098353
10 Moulds "Œuf filaire" for 5 pieces 8,9 x 13 cm
Th. 8,9 cm - Weight: ± 90 g - P. 132



074092
12 Moulds "Œuf vague" for 6 pieces 2 designs
8,2 x 13 cm - 9,6 x 15 cm - Th. 8,2 - 9,6 cm
Weight: ± 85 g - 120 g - P. 130

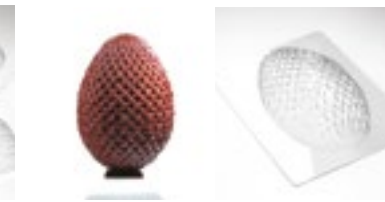

074086
12 Moulds "Œuf tissé" for 6 pieces 10 x 15 cm
Th. 10 cm - Weight: ± 130 g - P. 130



074090
12 Moulds "Œuf Fleurs" for 6 pieces 10 x 15 cm
Th. 10 cm - Weight: ± 130 g - P. 130



010314
12 Moulds "Œufs Diamant" for 6 pieces 3 designs
Large: 21,5 x 14 cm - Weight: ± 280 g - Medium:
14,2 x 9,4 cm - Weight: ± 130 g - Small: 12,2 x 8 cm
Weight: ± 90 g - P. 130



088239
12 Moulds "Œufs textures" for 6 pieces 2 designs
9,8 x 15 cm - Th. 9,8 cm Weight: ± 130 g - P. 130



074123
10 Moulds "Boîte à œufs" for 10 pieces
15,5 x 10,5 cm - Th. 4 cm - Weight: ± 90 g - P. 139



074100
24 Moulds "Poulettes" for 12 pieces 3 designs
9,4 x 9,9 cm, 8,5 x 10 cm, 10,5 x 6,5 cm
Th. 6,4 cm - Weight: ± 30 g - P. 139



088251
24 Moulds "Joyeux trio de poulettes" for 12 pieces
3 designs - 6,65 x 7,35 cm - 6 x 8,55 cm
6,2 x 8,7 cm - Th. ± 5 cm - Weight: ± 30 g
P. 139



088241
16 Moulds poulette "La comtesse" for 8 pieces
12,4 x 14 cm - Th. 10 cm - Weight: ± 115 g
P. 139



074096
12 Moulds "Poule et Coq" for 6 pieces - 2 designs
12 x 14,3 cm, 11 x 18,5 cm - Th. 8 cm - 9 cm
Weight: ± 65 g - 80 g - P. 139

010187
1 Mould "Socle Poulettes" for 15 pieces 4 x 4 cm
Weight: ± 8 g - P. 139



098354

12 Moulds "Cocoriquette" for 6 pieces 11,55 x 12 cm
Th. ± 7,52 cm Weight: : ± 85 g - P. 138

098355

12 Moulds "Cocorico" for 6 pieces 10,6 x 15,5 cm
Th. ± 7,7 cm Weight: : ± 90 g - P. 138



074088

12 Moulds "Les Binoclaris" for 6 pieces - 2 designs
9,8 x 14 cm, 9,8 x 10,9 cm - Th. 10,3 cm - 9,6 cm
Weight: ± 150 g - P. 137



074121

16 Moulds "Bord de mer" for 4 pieces 5 designs
Palms: 10 x 8 cm Th: 2,4 cm - Tubas: 4,5 x 10 cm
Th: 0,7 cm - Bottles: 11 x 2,6 cm Th: 1,3 cm - Big
masks: 5,5 x 3,1 cm - Th: 1 cm - Small masks:
4,2 x 2,2 cm Th: 1 cm - P. 140



098350

12 Moulds "Dino" for 6 pieces 13 x 13 cm
Th. 8,7 cm - Weight: : ± 130 g - P. 211



074078

12 Moulds "Baleine" for 6 pieces 17,5 x 8,7 cm
Th. 7,2 cm - Weight: ± 120 g - P. 140



074084

16 Moulds "Poussin matelot" for 8 pieces 4 designs
9,4 x 13 cm, 10,2 x 13 cm, 9,8 x 13 cm - Th. 7,6 cm
7,5 cm - 8,5 cm - 8 cm - Weight: ± 120 g - P. 140



074120

16 Moulds "Boîte à sardines" for 8 pieces
11,5 x 7 cm - Th. 3,3 cm - Weight: ± 70 g - P. 140



074104

12 Moulds "Hippocampe" for 6 pieces 9,8 x 13 cm
Th. 6 cm - Weight: ± 85 g - P. 140



074327

12 Moulds "Friture Lapinou" for 432 pieces
9 designs - Th. 1 cm - Weight: ± 6 g - P. 133



074323

12 Moulds "Friture sardine" for 216 pieces
3 designs 9 x 2,2 cm - H. 0,7 cm - Weight: ± 7 g
P. 133



098322

12 Moulds "Friture pieces d'or" for 336 pieces
4 designs ± ø 3,4 cm Weight: : ± 5 g - P. 212



088240

12 Moulds "Lapin dodu" for 6 pieces 7 x 12 cm
Th. 8,1 cm - Weight: ± 70 g - P. 137



074083

12 Moulds "Œuf Lapin" for 6 pieces 9,3 x 15 cm
Th. 9,5 cm - Weight: ± 130 g - P. 137



074108

12 Moulds "Teddy lapin" for 4 pieces - Body:
8,1 x 15 cm - Arm: 1,9 x 4,2 cm - Foot: 2,4 x 4,9 cm
Th. 7 cm - Weight: ± 100 g - P. 134



040153

8 Moulds lapin "Facettes" for 4 pieces
13 x 11,5 cm - Th. 7 cm - Weight: ± 115 g
P. 134



074112

20 Moulds "Petits Rabbits" for 10 pieces 8 x 8 cm
Th. 5 cm - Weight: ± 30 g - P. 134

074095

12 Moulds "Rabbits" for 6 pieces 12,5 x 12,5 cm
Th. 9 cm - Weight: ± 55 g - P. 134



074094
12 Moulds "Lapin Moustache" for 6 pieces
8,8 x 15 cm - Th. 5,6 cm - Weight: ± 90 g - P. 134



074093
12 Moulds "Lapin Peluche" for 6 pieces
10,3 x 14,7 cm - Th. 7,2 cm - Weight: ± 110 g
P. 134



074098
12 Moulds "Lapin Boule" for 6 pieces 11 x 11 cm
Th. 9,2 cm - Weight: ± 100 g - P. 134



074082
12 Moulds "Œuf Oreille" for 6 pieces 9,5 x 19,5 cm
Th. 9,5 cm - Weight: ± 160 g - P. 137



074309
12 Moulds "Lapin Astronaute" for 6 pieces
9,2 x 15 cm - Th. 7,1 cm - Weight: ± 80 g - P. 135



098250
10 Moulds "Chameau" for 5 pieces 12 x 7,5 cm
Th. 4 cm - Weight: ± 75 g - P. 144



074103
12 Moulds "Licorne" for 6 pieces 11,4 x 12,5 cm
Th. 7,5 cm - Weight: ± 85 g - P. 210



074305
20 Moulds "Mouton pelote" for 10 pieces
7,7 x 8,8 cm - Th. 7,2 cm - Weight: ± 45 g - P. 139



045565
20 Moulds "Locomotive" for 4 pieces
15 x 12,5 cm - H. 7 cm - Weight: ± 150 g - P. 213



074319
8 Moulds "Voiture Carotte" for 6 pieces
17 x 5,5 cm - Th. 5,7 cm - Weight: ± 80 g - P. 137



074307
12 Moulds "Fusée" for 6 pieces 8,7 x 14,9 cm
Th. 8,8 cm - Weight: ± 90 g - P. 135



087188
16 Moulds "Sous-marin" for 8 pieces
15 x 10,5 cm - Th. 10,5 cm - Weight: ± 100 g
P. 133



098366
6 Moulds "Pilotes de Pâques" for 6 pieces 2 designs
3,9 x 7 and 3,9 x 5,7 cm - Th. ± 4,1 cm and 4,25 cm
Weight: ± 15 g - 20g - P. 136



088250
8 Moulds "Carotte" for 8 pieces 4,2 x 15 cm
Th. 4,2 cm Weight: ± 55 g - P. 137



074080
16 Moulds "Van" for 6 pieces 19,4 x 7,2 cm
Th. 9 cm - Weight: ± 220 g - P. 213



087189
6 Moulds "Stylo" for 24 pieces 17,7 x 2,4 cm
Th. 2,3 cm - Weight: ± 20 g - P. 213

098364
18 Moulds "Bolide" for 6 pieces 20,4 x 9,2 cm
Th. ± 7 cm Weight: : ± 190 g - P. 136



098356
10 Moulds "Choc vinyl" for 4 pieces 23 x 20,5 cm
Th. 5,6 cm Weight: : ± 220 g- P. 216



074117
15 Moulds "Cornets de glace Oh zut" for 5 pieces
Cornet: 5,4 x 11,6 cm - Boule de glace: ø 8,2 cm
H. 4 cm - Weight: ± 60 g - P. 213



098369
16 Moulds "Coffre au trésor" for 8 pieces 13 x 10 cm
Th. 8,5 cm - Weight: ± 120 g - P. 213



074085
12 Moulds "Cloche Ding Dong" for 6 pieces
10,5 x 11 cm - Th. 10,5 cm - Weight: ± 80 g
P. 133

ENTREMETS MOULDS

SILICONE MOULDS



098304
1 Silicone mould "Bouchées élançées" for 24 pieces
ø 3,5 cm - H. 1,6 cm - Volume : 10 ml - P. 233



098310
1 Silicone mould "Bouchées coussin" for 15 pieces
4,2 x 4,2 cm - H. 1,5 cm - Volume : 18 ml - P. 233

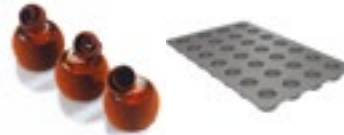

098305
1 Silicone mould "Bouchées concentriques" for
28 pieces ø 3 cm - H. 1,9 cm Volume : 11 ml - P. 233



088195
1 Silicone mould "Torsade" for 24 pieces ø 3 cm
H. 1,7 cm Volume : 79 ml - P. 233



098307
1 Silicone mould "Concentrique" for 6 pieces
ø 7 cm - H. 3,2 cm - Volume : 104 ml - P. 234



098312
1 Silicone mould "Larme" for 6 pieces 9,2 x 5,7 cm
H. 4,3 cm - Volume : 92 ml - P. 234



098308
1 Silicone mould "Twist" for 6 pieces ø 7,5 cm
H. 3,5 cm - Volume : 120 ml - P. 234



098302
1 Silicone mould "Rose" for 6 pieces ø 6 cm
H. 5,4 cm Volume : 114 ml - P. 234



098311
1 Silicone mould "Coussin" for 6 pieces 7,7 x 7,7 cm
H. 3 cm Volume : 120 ml - P. 234



098300
1 Silicone mould "Ourson" for 4 pieces
10,1 x 5,9 cm - H. 3 cm Volume : 116 ml - P. 234



088266
1 Silicone mould "Gobelet" for 6 pieces
ø 6,7 cm - H. 5,6 cm - Volume : 142 ml - P. 235



088265
1 Silicone mould "Petite tarte" for 6 pieces
ø 7,4 cm - H. 1,7 cm - Volume : 67 ml - P. 235



088196
1 Silicone mould "Étoile" for 6 pieces
ø 7,5 cm H. 4,5 cm - Volume : 102 ml - P. 235



010120
2 Silicone moulds "Magnum" for 12 pieces
9,2 x 4,8 cm - P. 2,5 cm - P. 235



010119
1 Silicone mould "Mini magnum" for 8 pieces
6,8 x 3,7 cm - P. 1,8 cm - P. 235



098314
1 Silicone mould "Palet" for 6 pieces
ø 6,5 mm - H. 3 cm - Volume : 85 ml - P. 235

004668
50 Flat birch sticks 11,2 x 1 cm - P. 235

004667
50 Mini flat birch sticks - 7,2 x 0,8 cm - P. 235



087078
1 Silicone mould "Vrille" for 6 pieces ø 7 cm
H. 4,5 cm - Volume : 120 ml - P. 235



098315
1 Silicone mould "Ovoïde" for 9 pieces
8,2 x 4,3 cm H. 3,2 cm - Volume : 79 ml - P. 235



010051
1 Silicone mould "Bouchon de parfum" for 1 piece - P. 235

098313
1 Silicone mould "Bûche chalet" for 1 piece
17,2 x 8,6 cm H. 7,4 cm - Volume : 770 ml - P. 237

010297
1 Silicone mould "Parfum" for 6 pieces - ø 8 cm
H. 4 cm - P. 235



098306
1 Silicone mould "Concentrique" for 1 piece
ø 14,1 cm - H. 5,2 cm - Volume : 690 ml - P. 236



098303
1 Silicone mould "Charlotte" for 1 piece ø 15,5 cm
H. 4 cm - Volume : 466 ml - P. 236



098301
1 Silicone mould "Bûche torsade" for 1 piece
19,3 x 9,2 cm - H. 6,8 cm - Volume : 640 ml - P. 232



088197
1 Silicone mould "Étoile" for 1 piece ø 19,5 cm
H. 5 cm - Volume : 776 ml - P. 236



098309
1 Silicone mould "Twist" for 1 piece ø 14,3 cm
H. 5,7cm - Volume : 725 ml - P. 236

SILICONE MATS

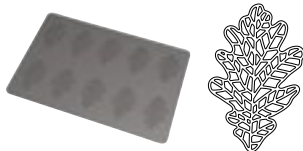

098401
1 Silicone mat "Feuille de chêne" of
10 prints 6,3 x 4,1 cm - Th. 1,5 mm - P. 239

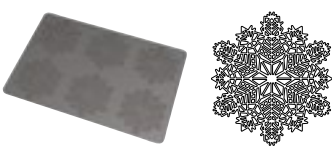

098402
1 Silicone mat "Flocon givré" of
6 prints ø 8,8 cm - Th. 1,5 mm - P. 239

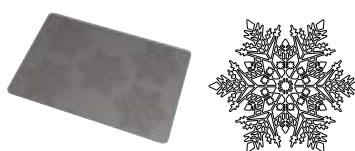

098403
1 Silicone mat "Flocon Arctique" of
5 prints ø 10,1 cm - Th. 1,5 mm - P. 239

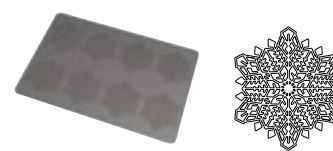

098404
1 Silicone mat "Flocon polaire" of
8 prints ø 7,2 cm - Th. 1,5 mm - P. 239



098405
1 Silicone mat "Plumes" of 6 prints
6 designs ± 4,1 x 9,9 cm - Th. 1,5 mm - P. 239



098406
1 Silicone mat "Feuille" of
10 prints 3,7 x 6,4 cm - Th. 1,5 mm - P. 239

KING'S CAKE STENCILS



098389
1 Stencil for King's cake
"Tourbillon" for 1 piece ø 22 cm
(Usable for King's cake from
ø 16 cm) - P. 241

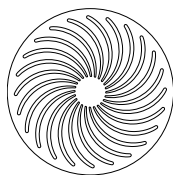

098390
1 Stencil for King's cake
"Pithiviers" for 1 piece ø 22 cm
(Usable for King's cake from
ø 16 cm) - P. 241

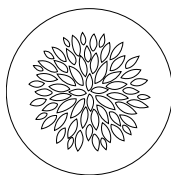

098386
1 Stencil for King's cake "Envol"
for 1 piece ø 22 cm (Usable for
King's cake from ø 16 cm)
P. 241

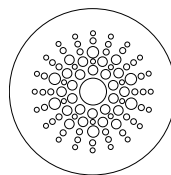

098387
1 Stencil for King's cake "Bubble"
for 1 piece ø 22 cm (Usable for
King's cake from ø 16 cm)
P. 241

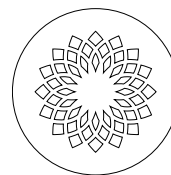

098388
1 Stencil for King's cake "Rosace"
for 1 piece ø 22 cm (Usable for
King's cake from ø 16 cm)
P. 241

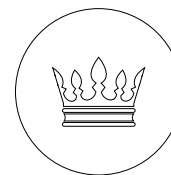

098385
1 Stencil for King's cake "Le roi"
for 1 piece ø 22 cm (Usable for
King's cake from ø 16 cm)
P. 241

STENCILS

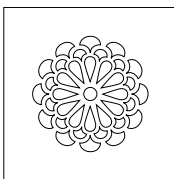

098391
1 Stencil "Bouquet" for 1 piece
15 x 15 cm - Th. 1,5 mm
Pattern size: ø 10 cm - P. 243

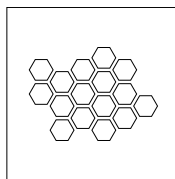

098392
1 Stencil "Alvéoles" for 1 piece
15 x 15 cm - Th. 1,5 mm
Pattern size: ± 11 x 8 cm - P. 243

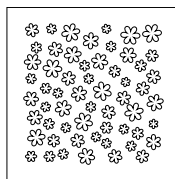

098393
1 Stencil "Fleurettes" for 1 piece
15 x 15 cm - Th. 1,5 mm - Pattern
size: ± 12 x 12 cm - P. 243

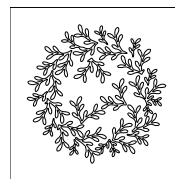

098394
1 Stencil "Feuillage" for 1 piece
15 x 15 cm - Th. 1,5 mm - Pattern
size: ± 12 x 12 cm - P. 243

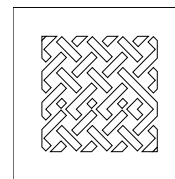

098395
1 Stencil "Mosaïque" for 1 piece
15 x 15 cm - Th. 1,5 mm - Pattern
size: ± 10 x 10 cm - P. 243

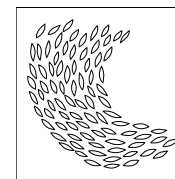

098396
1 Stencil "Envolée" for 1 piece
15 x 15 cm - Th. 1,5 mm - Pattern
size: ± 12,9 x 12,8 cm - P. 243

STRUCTURE SHEETS FOR ENTREMETS



010294
10 Structure sheets "Rondin" 56,5 x 36,5 cm
P. 259



009808
10 Structure sheets "Matelassé" 56,5 x 36,5 cm
P. 259



009836
10 Structure sheets "Mouvance" 56,5 x 36,5 cm
P. 259



060888
10 Structure sheets "Feuillage" 56,5 x 36,5 cm
P. 259

060153

10 Structure sheets "Rondin" for yule log
52,7 x 17,7 cm - P. 109 and P. 259



009741
10 Structure sheets "Ondulé" 56,5 x 36,5 cm
P. 259



074351
10 Structure sheets "Écorce" 56,5 x 36,5 cm
P. 259

065067

10 Structure sheets "Écorce" for yule log
52,7 x 17,7 cm - P. 109 and P. 259



036161
10 Structure sheets "Déstructuré" 56,5 x 36,5 cm
P. 259

060152

10 Structure sheets "Déstructuré" for yule log
52,7 x 17,7 cm - P. 109 and P. 259

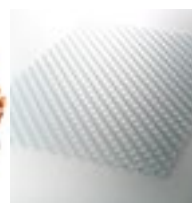

000368
10 Structure sheets "Ananas" 56,5 x 36,5 cm
P. 259

060154

10 Structure sheets "Ananas" for yule log
52,7 x 17,7 cm - P. 109 and P. 259



060889
10 Structure sheets "Envol" 56,5 x 36,5 cm
P. 259



009891
10 Structure sheets "Petit Matelassé"
56,5 x 36,5 cm - P. 258



074289
10 Structure sheets "Fleurs" 56,5 x 36,5 cm - P. 258

060156
10 Structure sheets "Petit Matelassé" for yule log
52,7 x 17,7 cm - P. 108 and - P. 258

TEARABLE MOULDS



070552
100 Entremets moulds "Rond plat" for 100 pieces
ø 14 cm - H. 4 cm Tearable moulds - P. 249

070553
100 Entremets moulds "Rond plat" for 100 pieces
ø 16 cm - H. 4 cm Tearable moulds - P. 249

070554
100 Entremets moulds "Rond plat" for 100 pieces
ø 18 cm - H. 4 cm Tearable moulds - P. 249

070555
100 Entremets moulds "Rond plat" for 100 pieces
ø 20 cm - H. 4 cm Tearable moulds - P. 249



070556
100 Entremets moulds "Rond plat" for 100 pieces
ø 14 cm - H. 4,5 cm Tearable moulds - P. 249

070557
100 Entremets moulds "Rond plat" for 100 pieces
ø 16 cm - H. 4,5 cm Tearable moulds - P. 249

070558
100 Entremets moulds "Rond plat" for 100 pieces
ø 18 cm - H. 4,5 cm Tearable moulds - P. 249

070559
100 Entremets moulds "Rond plat" for 100 pieces
ø 20 cm - H. 4,5 cm Tearable moulds - P. 249



070564
100 Entremets moulds "Carré plat arrondi"
for 100 pieces 14 x 14 cm - H. 4 cm Tearable moulds
P. 249

070565
100 Entremets moulds "Carré plat arrondi"
for 100 pieces 16 x 16 cm - H. 4 cm Tearable moulds
P. 249

070566
100 Entremets moulds "Carré plat arrondi"
for 100 pieces 18 x 18 cm - H. 4 cm Tearable moulds
P. 249



074074
30 Entremets moulds "Œuf 4 personnes" for 30
pieces 12 x 19 cm - H. 4 cm Tearable moulds
P. 251

074075
30 Entremets moulds "Œuf 6 personnes" for 30
pieces 16,2 x 24 cm - H. 4 cm Tearable moulds
P. 251



087009
100 Entremets moulds "Rond plat arrondi"
for 100 pieces ø 14 cm - H. 3 cm Tearable moulds
P. 250

087011
100 Entremets moulds "Rond plat arrondi"
for 100 pieces ø 16 cm - H. 3 cm Tearable moulds
P. 250

087013
100 Entremets moulds "Rond plat arrondi"
for 100 pieces ø 18 cm - H. 3 cm Tearable moulds
P. 250

087018
100 Entremets moulds "Rond plat arrondi"
for 100 pieces ø 20 cm - H. 3 cm Tearable moulds
P. 250



087010
100 Entremets moulds "Rond plat arrondi"
for 100 pieces ø 14 cm - H. 3,5 cm Tearable moulds
P. 250

087012
100 Entremets moulds "Rond plat arrondi"
for 100 pieces ø 16 cm - H. 3,5 cm Tearable moulds
P. 250

087014
100 Entremets moulds "Rond plat arrondi"
for 100 pieces ø 18 cm - H. 3,5 cm Tearable moulds
P. 250

087019
100 Entremets moulds "Rond plat arrondi"
for 100 pieces ø 20 cm - H. 3,5 cm Tearable moulds
P. 250



070560
100 Entremets moulds "Rond plat arrondi"
for 100 pieces ø 14 cm - H. 4 cm Tearable moulds
P. 250

070561
100 Entremets moulds "Rond plat arrondi"
for 100 pieces ø 16 cm - H. 4 cm Tearable moulds
P. 250

070562
100 Entremets moulds "Rond plat arrondi"
for 100 pieces ø 18 cm - H. 4 cm Tearable moulds
P. 250

070563
100 Entremets moulds "Rond plat arrondi"
for 100 pieces ø 20 cm - H. 4 cm Tearable moulds
P. 250



070567
30 Entremets moulds "Dessus de tarte"
for 30 pieces ø 15 cm H. 1,8 cm Tearable moulds
P. 251

070568
30 Entremets moulds "Dessus de tarte"
for 30 pieces ø 17 cm H. 1,8 cm Tearable moulds
P. 251

087075
30 Entremets moulds "Dessus de tarte"
for 30 pieces ø 18 cm H. 2 cm Tearable moulds
P. 251

070569
30 Entremets moulds "Dessus de tarte"
for 30 pieces ø 19 cm H. 1,8 cm Tearable moulds
P. 251



070514
30 Entremets moulds "Lettre" for 30 pieces
20,5 x 14 cm - H. 3,5 cm Tearable moulds - P. 251



060224
10 Entremets moulds "Spirale" for 10 pieces
ø 18 cm - H. 1,5 cm Tearable moulds - P. 251



098384
30 Moulds for entremets "Cœur 4 personnes" for
30 pieces 14 x 14 cm - H. 3,5 cm
Tearable moulds - P. 251

INDIVIDUALS ENTREMETS MOULDS

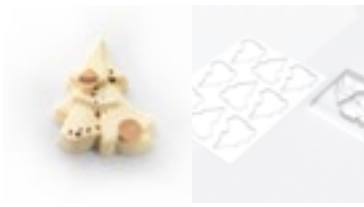

087015
22 Entremets moulds "Sapin" for 36 pieces - Top:
8,75 x 11,2 cm - H. 2,4 cm - Moulds with support
jams - Bottom: 8,97 x 11,4 cm - H. 0,5 cm
Moulds without support jams - P. 99



074233
30 Entremets moulds "Étoile" for 180 pieces
8 x 7,6 cm - H. 4 cm Moulds with support jams
P. 99



070525
30 Entremets moulds "Bonnet de Père Noël" for
120 pieces ø 7 cm - H. 5,2 cm - Moulds with support
jams - P. 99



070545
30 Entremets moulds "Champagne" for 90 pieces
5,8 cm x 13,5 cm - H. 3 cm - Moulds with support
jams - P. 99



009790
10 "Molines" tubes 58 cm ø 3,5 cm and 20 covers
100 Rhodoïde sheets neutral 58 x 12 cm - P. 252

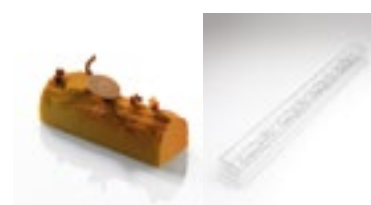

070575
10 Entremets moulds "Bûchette rondin" 54 x 3,8 cm
H. 3,8 cm - Moulds with support jams - P. 99



045841
10 Entremets moulds "Mini-bûchette" 54 cm x 3,8 cm
H. 3,8 cm - P. 99



070511
30 Entremets moulds "Souche" for 120 pieces
ø 7 cm - H. 3,5 cm - Moulds with support jams
P. 30

005002
100 Rhodoïde sheets neutral 58 x 12 cm

048002
100 Rhodoïde sheets neutral 52,7 x 9,5 cm to insert
into the mould 045841



070529
30 Entremets moulds "Citrouille" for 120 pieces
ø 7,5 cm - H. 1,8 cm - Moulds with support jams
P. 30



074234
30 Entremets moulds "Citrouille" for 120 pieces
8,5 x 8,9 cm - H. 3,3 cm - Moulds with support
jams - P. 30



010354
1 Tray for entremets individual "Ronds"
for 45 pieces ø 6 cm - H. 4 cm - P. 252

005000
200 Rhodoïde sheets neutral 19,5 x 4 cm



070546
30 Entremets moulds "Charlotte" for 120 pieces
8 x 8,3 cm - H. 3,2 cm - Moulds with support jams
P. 252



009941
10 Entremets tubes "sucettes" - ø 3,5 cm - H. 8 cm
P. 252

005013
200 Rhodoïde sheets neutral 12 x 8 cm

004568
200 Flat beech sticks 9,3 x 1,8 cm



074245
30 Entremets moulds "Œuf bombé" for 120 pieces
6 x 10 cm - H. 3 cm - Moulds with support jambs
P. 143



074064
30 Entremets moulds "Lapinou"
for 120 pieces 10 x 8 cm - H. 4 cm
Moulds with support jambs - P. 143



070548
30 Entremets moulds "Pomme" for 60 pieces
Top ø 7,4 cm - H. 2,6 cm - Moulds with support
jambs - Bottom ø 7,4 cm - H. 3,7 cm - Moulds with
support jambs - P. 117



074061
30 Entremets moulds "Bouche" for 180 pieces
9,5 x 5,6 cm - H. 3,5 cm - Moulds with support
jambs - P. 117



070515
30 Entremets moulds "Cœur spirale" for 120 pieces
8,4 x 8 cm - H. 3,3 cm - Moulds with support jambs
P. 117



088192
30 Entremets moulds "Cœur lisse" for 60 pieces
11 x 11 cm - H. 3,5 cm - Moulds with support jambs
P. 117



074063
30 Entremets moulds "Cœur drapé"
for 120 pieces 8,5 x 7,5 cm - H. 3,8 cm
Moulds with support jambs - P. 117



070520
30 Individual entremets moulds "Petite tarte"
for 120 pieces ø 7,4 cm - H. 1,7 cm - Moulds with support
jambs - P. 253



074060
30 Individual entremets moulds "Petite tarte rose"
for 120 pieces ø 7,4 cm - H. 2 cm - P. 117 and P. 253



074059
30 Individual entremets moulds "Petite tarte fleur"
for 120 pieces ø 7,4 cm - H. 1,7 cm
Moulds with support jambs - P. 253



070534
30 Individual entremets moulds "Petite tarte
meringuée" for 120 pieces ø 7,4 cm - H. 2,7 cm
Moulds with support jambs - P. 253



070535
30 Individual entremets moulds "Petite tarte
pochage" for 120 pieces ø 7,4 cm - H. 2,3 cm -
Moulds with support jambs - P. 253



098316
30 Individual entremets moulds "Flocon" for 60
pieces - Top: 7,4 x 7,1 cm - H. 3,1 cm Moulds with
support jambs - Bottom: 7,9 x 7,55 cm - H. 0,5 cm
Moulds without support jambs - P. 98



060221
16 Individual entremets moulds "Spirale" for
48 pieces ø 8 cm - H. 1,5 cm - P. 253



070536
30 Individual entremets moulds
"Palet" for 150 pieces ø 8 cm
H. 1,7 cm - Moulds with support
jambs - P. 117 and P. 253

ENTREMETS MOULDS



087016
45 Entremets moulds "Sapin" for 30 pieces - Top: 17,7 x 22,6 cm - H. 4,5 cm - Moulds with support jambs - Bottom: 18,2 x 23,2 cm - H. 0,5 cm - Moulds without support jambs - P. 101



070528
30 Entremets moulds "Igloo" for 30 pieces 19,5 x 21 cm - H. 9 cm - Moulds with support jambs P. 101



070524
30 Entremets moulds "Bonnet de Noël" for 30 pieces ø 18 cm - H. 15 cm - P. 101



074235
30 Moulds Entremets "Étoile" for 30 pieces 21 x 22 cm - H. 5,5 cm - Moulds with support jambs - P. 101



065313
10 Entremets moulds "Sphère" to clip for 5 pieces ø 12 cm H. 10 cm - Moulds with support jambs - P. 101



088191
60 Entremets moulds "Couronne" for 30 pieces Top : ø 21,9 cm - H. 2,3 cm Bottom : ø 22,3 cm - H. 0,8 cm - P. 101



065150
5 Structure sheets pre-folded "Bois" for cube 10 cm - P. 30

065122
2 Blisters "Attache-boules" so 80 prints ø 3 cm - H. 0,8 cm - P. 101

009952
1 Mould "Cube" for 5 pieces 10 x 10 cm - H. 10 cm - P. 30

005018
100 Rhodoïde sheets neutral 10 x 10 cm - P. 30

009910
1 Inox mould Cube 10 x 10 cm - H. 10 cm - P. 30



088248
30 Entremets moulds "Ourson" for 30 pieces 13,1 x 22,3 cm - H. 6,65 cm - Moulds with support jambs - P. 100 and 257



070517
30 Entremets moulds "Souche" for 30 pieces ø 18 cm H. 4 cm - Moulds with support jambs P. 30 and P. 255



070530
30 Entremets moulds "Citrouille" for 30 pieces ø 16 cm - H. 4,4 cm - Moulds with support jambs P. 31



074243
30 Entremets moulds "Citrouille" for 30 pieces 15,8 x 16,5 cm - H. 4,7 cm - Moulds with support jambs - P. 116



087061
60 Entremets moulds "Panama" for 30 pieces Top: 12,7 x 15 cm - H. 7 cm - Moulds with support jambs - Bottom: 21 x 21 cm - H. 1,3 cm - Moulds with support jambs - P. 255



070516
30 Entremets moulds "Cœur matelassé" for 30 pieces 14,5 x 14,5 cm - H. 3,5 cm - Moulds with support jambs - P. 116



098382
30 Entremets moulds "Cœur spirale" for 30 pieces 17,3 x 17,8 cm - H. 5,5 cm - Moulds with support jambs - P. 116



074070
30 Entremets moulds "Cœur diamant" for 30 pieces 14,5 x 14,5 cm - H. 4 cm - Moulds with support jambs - P. 116

098383
30 Entremets moulds "Cœur spirale 2 personnes" for 60 pieces 11,16 x 11,5 cm - H. 3,7 cm - Moulds with support jambs - P. 116



074067
30 Entremets moulds
"Bouche" for 30 pieces
20 x 12 cm - H. 5 cm
Moulds with support
jambes - P. 116



074066
30 Entremets moulds "Cœur drapé"
for 30 pieces 15,1 x 13,3 cm - H. 6,4 cm
Moulds with support jambes - P. 116



087017
30 Entremets moulds "Cœur" for 60 pieces
11,2 x 11,8 cm - H. 3,8 cm - Moulds with support
jambes - P. 116



074068
30 Entremets moulds "Nid" for 30 pieces ø 14 cm
H. 2 cm - Moulds with support jambes - P. 143

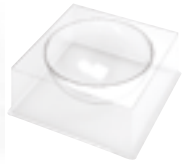

070518
30 Moulds entremets "Demi-sphère" for 30 pieces
ø 14 cm - H. 7 cm - Moulds with support jambes
P. 257



070541
30 Moulds "Rose" (top) for 30 pieces ø 15 cm
H. 1,2 cm - Moulds with support jambes - P. 257

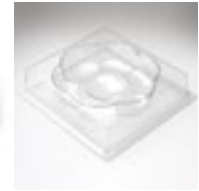

074071
30 Entremets moulds "Fleur" for 30 pieces
16 x 17 cm - H. 4 cm - Moulds with support jambes
P. 257

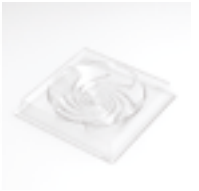

070537
30 Entremets moulds "Rosace" for 30 pieces ø 15 cm
H. 1,5 cm - Moulds with support jambes - P. 257

070522
30 Entremets moulds "Demi-sphère" for 30 pieces
ø 18 cm - H. 9 cm - Moulds with support jambes
P. 257



088188
30 Entremets moulds "Noisette 4 personnes"
for 30 pieces 14 x 14,5 cm - H. 4 cm
Moulds with support jambes - P. 254



088189
30 Entremets moulds "Noisette 6 personnes"
for 30 pieces 17 x 18 cm - H. 4 cm
Moulds with support jambes - P. 254



074236
30 Entremets moulds "Candy" for 30 pieces
ø 17 cm - H. 4 cm - Moulds with support jambes
P. 255

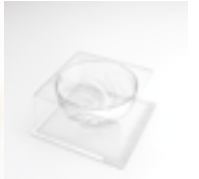

070521
30 Entremets moulds "Vrille" for 30 pieces
ø 17 cm - H. 9,5 cm - Moulds with support jambes
P. 257

070542
30 Entremets moulds "Vrille" for 30 pieces
ø 14 cm - H. 7 cm - Moulds with support jambes
P. 257



074246
30 Entremets moulds "Œuf bombé" for 30 pieces
16 x 26 cm - H. 5 cm - Moulds with support jambes
P. 143



074065
30 Entremets moulds "Lapin" for 30 pieces
14,4 x 17,8 cm - H. 7 cm Moulds with support jambes
P. 143



070513
30 Entremets moulds "St Honoré" for 30 pieces
ø 16 cm - H. 6 cm - P. 255

MOULDS “CADRES PÂTISSIERS”



074072
10 Entremets moulds “Cadre Pâtissier” for
10 pieces 57 x 37 cm - H. 3,5 cm - P. 256



070584
10 Entremets moulds “Cadre Pâtissier” for
10 pieces 57 x 37 cm - H. 4 cm - P. 256



074073
10 Entremets moulds “Cadre Pâtissier” for
10 pieces 57 x 37 cm - H. 4,5 cm - P. 256

YULE LOG MOULDS



070587
10 Yule log moulds “Standard” 54 x 8 cm
H. 6,5 cm - P. 107



060234
10 Moulds “Petite bûche gouttière” 54 x 5,7 cm
H. 5 cm - P. 107



045841
10 Moulds “Mini-bûchette” 54 x 3,8 cm - P. 107



065147
10 Yule log moulds “Ooreka” 54 x 8 cm
H. 6,5 cm - Moulds with support jamba - P. 104

048001
100 Rhodoïde sheets neutral 52,7 x 17,7 cm
to insert into the mould 070587 - P. 107

060235
100 Rhodoïde sheets neutral 52,7 x 12,7 cm
to insert into the mould 060234 - P. 107

048002
100 Rhodoïde sheets neutral 52,7 x 9,5 cm
to insert into the mould 045841 - P. 107



098370
10 Yule log moulds “Vague” 54 X 8 cm
H. 6,5 cm - Moulds with support jamba - P. 104



088194
10 Yule log moulds “Pyramide” 54 x 9 cm
H. 7 cm - Moulds with support jamba - P. 104



088193
30 Yule log moulds “Plissée” for 30 pieces
23,2 x 7,3 cm - H. 7,6 cm - Moulds with support
jamba - P. 102



070539
30 Yule log moulds “Rondin” for 30 pieces
23,6 x 6,6 cm - H. 3,5 cm - Moulds with support
jamba - P. 103



070573
10 Yule log moulds “Facettes” 54 x 8 cm
H. 6,5 cm - Moulds with support jamba - P. 105



070574
10 Yule log moulds “Fond plat” 54 x 8 cm
H. 6,5 cm - Moulds with support jamba - P. 105



000366
4 Yule log moulds “Boules” 51 x 8 cm
H. 6,5 cm - Moulds with support jamba - P. 105



074237
30 Entremets moulds “Lingot 24 cm” for 30 pieces
24 x 8 cm - H. 5,5 cm - Moulds with support jamba
P. 104

074238
30 Entremets moulds “Lingot 16 cm” for 30 pieces
16 x 8 cm - H. 5,5 cm - Moulds with support jamba
P. 104



060233
10 Yule log moulds "Ondes" 54 x 8 cm
H. 6,5 cm - Moulds with support jamba - P. 105



060232
10 Yule log moulds "Montagne" 54 x 7 cm
H. 8 cm - Moulds with support jamba - P. 105



074244
10 Yule log moulds "Rectangle arrondi" 54 x 8 cm
H. 6,5 cm - Moulds with support jamba - P. 104



009992
1 Yule log mould "Tube" 50 cm ø 6,4 cm
and 2 covers - P. 106

005019
100 Rhodoïde sheets neutral 50 x 21 cm - P. 106



070526
30 Yule log moulds "Champagne" for 30 pieces
25 x 9 cm - H. 5,6 cm - Moulds with support jamba
P. 106

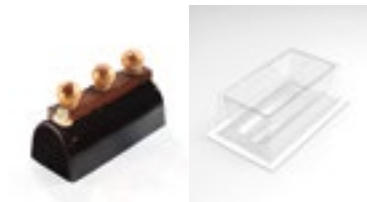

074239
30 Yule log moulds "6 parts" for 30 pieces
18 x 8 cm - H. 6,5 cm - Moulds with support jamba
P. 106



070519
30 Yule log moulds "Trésor" for 30 pieces 20 x 8 cm
H. 7,2 cm - Moulds with support jamba - P. 106



087068
10 Yule log moulds "Dessus plat" 54 x 8 cm
H. 6,5 cm - Moulds with support jamba - P. 105



070544
30 Yule log moulds "Nuage" for 30 pieces 20 x 11 cm
H. 7 cm - Moulds with support jamba - P. 106



074240
30 Yule log moulds "Arrondie" for 30 pieces
20 x 8 cm - H. 7 cm - Moulds with support jamba
P. 104

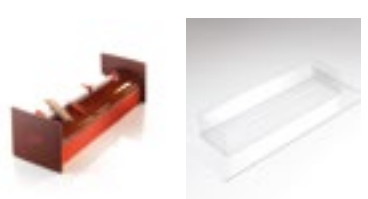

070538
30 Yule log moulds "Dessous de bûches" for 30
pieces 24 x 7 cm - H. 4 cm - P. 103



070571
30 Moulds "Bûche Mont blanc" for 15 pieces:
Top: 22,8 x 6 cm - H. 2,8 cm Moulds with support
jamba - Bottom: 25 x 8 cm H. 4,5 cm - P. 106



070532
30 Yule log moulds "Marquise" for 30 pieces
23,6 x 6,6 cm - H. 2 cm - Moulds with support
jamba - P. 103



070533
30 Yule log moulds "Duchesse" for 30 pieces
23,6 x 6,6 cm - H. 3 cm - Moulds with support
jamba - P. 103



070540
30 Yule log moulds "Éminence" for 30 pieces
23,6 x 6,6 cm - H. 2,5 cm - Moulds with support
jamba - P. 103

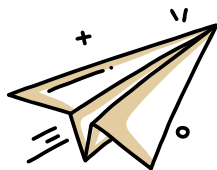

Keep in touch

WITH THE MANUFACTURE OF EMOTIONS



ORDER 24 HOURS A DAY ON OUR WEBSHOP
www.pcb-creation.fr

ETIENNE LEROY • HÉLÈNE KERLOEGUEN
TOM COLL • PASCAL HAINIGUE • GABRIEL LE QUANG
JÉRÉMY MASSING • CLAIRE HEITZLER
KIM VIDELO • ABEL NESSON



PCB CREATION

Manufacture d'émotions

1 RUE DE HOLLANDE • CS 60067
67232 BENFELD CEDEX • FRANCE
T. +33 (0)3 88 587 333
pcb.creation@pcb-creation.fr
www.pcb-creation.com

