



bamix[®]
of Switzerland



Brilliantly simple. Simply brilliant.



bamix[®]
of Switzerland

Why bamix[®]?

bamix[®] – the versatile hand-held blender that can do much more than a food processor.

The **bamix[®]** concept is based on a few, easy-to-use components:

- › **bamix[®]** with 200 W and 17,000 rpm
- › **Stand** for accessories
- › **Multi-purpose blade** for mincing, puréeing, straining and stirring stodgy and heavy foods
- › **Beater blade** for whipped cream, whipped egg white, frappés, etc.
- › **Whisk blade** for preparing salad dressings and mayonnaise, mixing light doughs, mashing potatoes, etc.
- › **Meat/vegetable blade** for chopping meat, fish and long-fibre vegetables
- › **Processor and grinder** for milling cereals, chopping herbs, spices and cheese, grinding coffee, sugar, etc.

bamix[®] does away with time-consuming food preparation. Designed for modern kitchens and a versatile cuisine. No need for additional kitchen appliances.

bamix[®] offers a lot of advantages

bamix[®]
of Switzerland

Versatile

The **bamix[®]** is the perfect appliance for a huge range of different tasks. It can be safely used in small containers and fragile glassware as well as in hot saucepans on the hob. The **bamix[®]** comes with a double insulated and fully sealed housing for deep immersion into hot and cold liquids.

Easy to use

Thanks to its unique and ergonomically optimised design, the **bamix[®]** does not slip from your hand and can be controlled with a single finger. All accessories are designed for easy attachment and removal.

Easy to clean

The **bamix[®]** is extremely easy to clean. Simply hold the cutter guard under hot running water – done!

Storage

Placed in its stand or wall bracket, the **bamix[®]** is always close at hand and leaves enough space even in a small kitchen.

Quality

The **bamix[®]** is a Swiss quality product made to last. It will serve you for many years to come. All parts are made from non-corrosive material and can be ordered from stock at any time. The strong motor is a **bamix[®]** design. All motors are produced at the company's factory in Switzerland. **100% made in Switzerland.**

Applications

The **bamix[®]** is popular with gourmet chefs and other food professionals, as well as with people who just love to cook at home. They know that they can always rely on their **bamix[®]**, as it has been designed for durability.

bamix[®] is simply brilliant

bamix[®] saves time, money and hassle. As it takes the work out of preparing food, the **bamix[®]** will soon be the most used appliance in your kitchen – from breakfast in the morning to late evening dinners.

Repair service

Many kitchen appliances cannot be repaired – but the **bamix[®]** is different. Many of our devices have been in use for over 30 years and can still be repaired, should there ever be a problem.

Lower power rating – higher performance

Thanks to the excellent quality of the product and the long-time spare parts warranty, you do not need to replace your **bamix[®]** every few years, as a repair is normally the better option. By opting for high speeds and perfect torques, we have been able to achieve excellent performance at comparatively low power ratings.



bamix[®] history

bamix[®] – a success story starting in 1954

For more than 60 years, **bamix[®]** has been conquering kitchens all over the world.

Conceived by Swiss inventor Roger Perrinjaquet, the first **bamix[®]** was sold in 1954 and the appliance has since become the trusted companion of food lovers around the globe. Every year, around 400,000 **bamix[®]** appliances are made at the factory of ESGE AG in Mettlen, Switzerland.

Looking at conventional food processors, the inventor of the device clearly saw the advantages of an appliance that could be used directly in the containers in which food is prepared, doing away with moving ingredients from one bowl to another. He called his invention **bamix[®]**, based on the French words for beating (*battre*) and mixing (*mixer*).

100% made in Switzerland.
Hand-made in our factory.

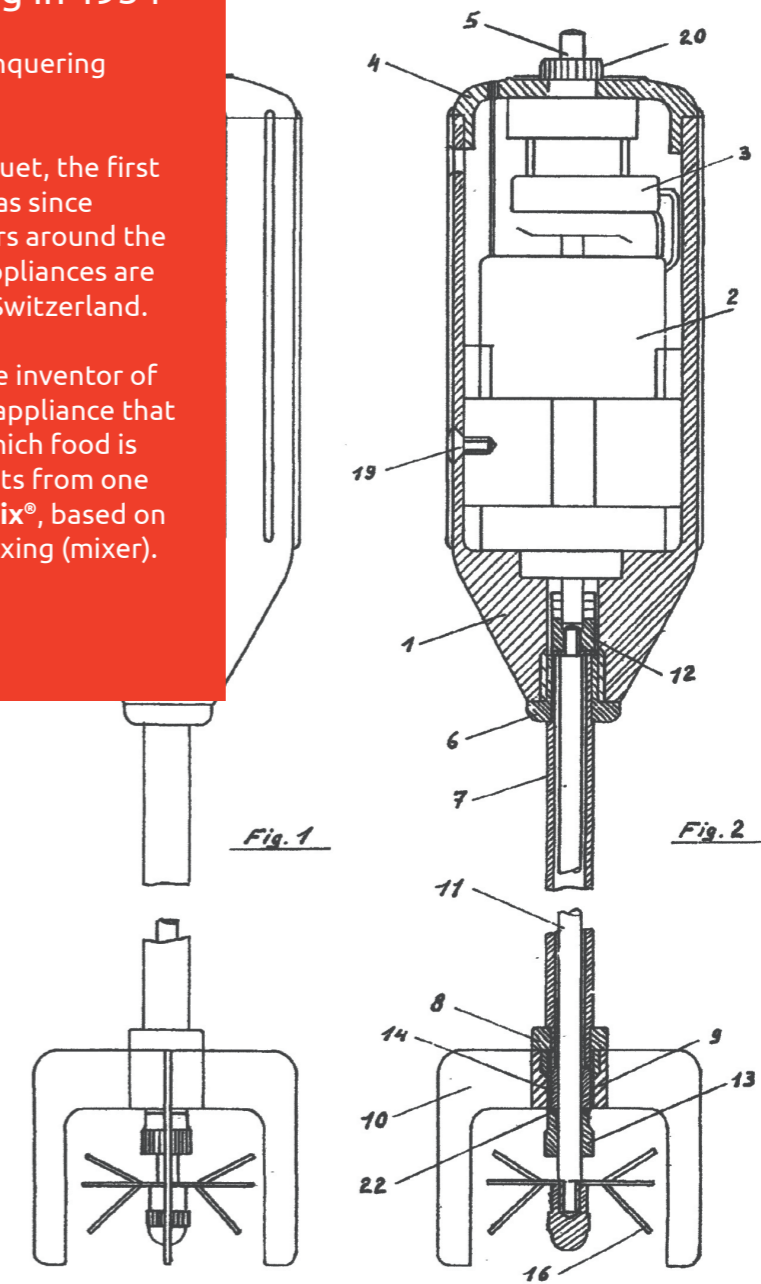



All-in-one kitchen appliance

bamix® is the smallest yet most efficient and versatile kitchen appliance in the world. Thanks to the various **bamix®** accessories, the appliance is the ideal helper for a huge range of tasks.

It can be used to chop, mince, purée, emulsify, mix, blend, froth, grind, pulverise, grate and whip food. At the same time, the **bamix®** is extremely easy to operate and clean.

With only two accessories, namely the SliceSy® and the processor, your **bamix®** becomes the master of all tasks in your kitchen. Small and compact.

bamix® 100% Swiss quality

For the manufacturers of the **bamix®**, sustainability is not just a slogan but part of the idea behind the product. For the last 60 years, the company has worked hard to protect resources, for instance by making sure that even a **bamix®** that is twenty years old can still be repaired. At the factory in Mettlen, the appliances are screwed together rather than glued and welded, so that they can be opened at any time for a thorough inspection and repair.

As it is made from top-quality materials, your **bamix®** is however unlikely to ever break down. The extremely powerful motor is made to last, and makes very little noise. The timeless design of the appliance is based entirely on functionality and good ergonomics.

Every day, top chefs all over the world rely on the **bamix®** to prepare their creations. In their kitchens, the **bamix®** rarely stands still. For more than 12 million users, the **bamix®** has become an indispensable kitchen appliance.



LUXURYLINE



Accessories



Multi-purpose blade



Beater blade



Whisk blade



Meat/vegetable blade



Processor



PowderDisc



Stand



Beaker 600 ml



Jug 1000 ml



Mayonnaise tub



The luxury edition

- › Premium gift
- › 24 carat gold plated
- › Striking look
- › Eye-catcher
- › Perfect for designer kitchen
- › High-performance appliance
- › In luxury sales box



queen

Technical data

- › 200 W heavy-duty AC motor
- › Double insulation
- › Twin switch
- › 2 speed settings (depending on motor rating):
Step 1 12,000 rpm
Step 2 17,000 rpm



Accessories



Multi-purpose blade



Beater blade



Whisk blade



Optional: Meat Mincer



Processor



Jug 1000 ml



Stand



The eye-catcher

- › Brings colour to your kitchen
- › Contemporary colour range
- › Striking look
- › Product in timeless design
- › With refreshing box-sleeve



Technical data

- › 200W heavy-duty AC motor
- › Double insulation
- › Softgrip safety switch
- › 2 speed settings:
 - Step 1** 12,000 rpm
 - Step 2** 17,000 rpm



*Prepare your
baby food*

Accessories



Multi-purpose blade



Beater blade



Whisk blade



Beaker 400 ml



Stand

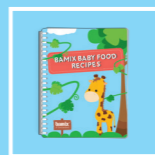

Baby food recipes



Baby food container



The family appliance

- › Ideal present for young families
- › Attractive modern design
- › For much more than just baby food
- › With baby food recipe booklet
- › With handy baby food container for on the road

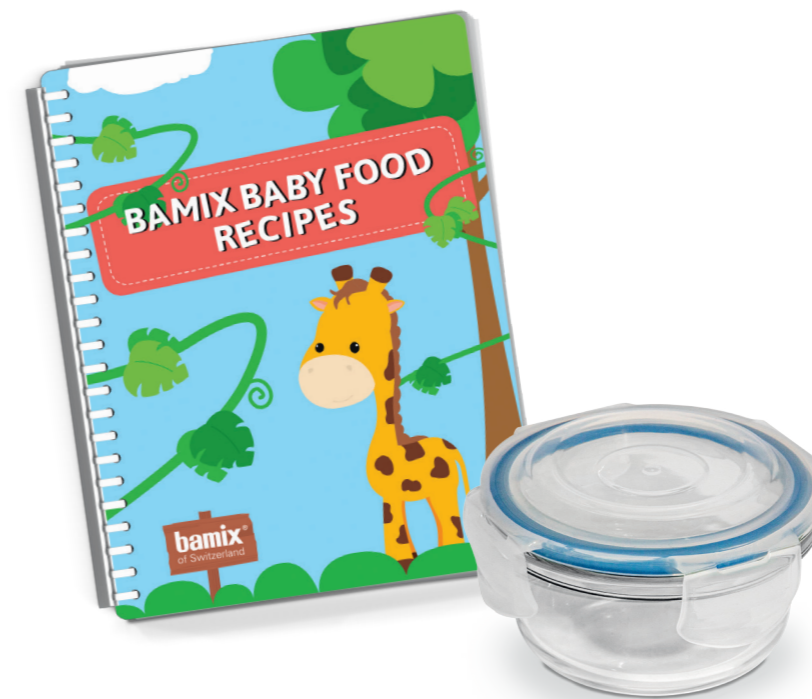

white

Technical data

- › 200W heavy-duty AC motor
- › Double insulation
- › Twin switch for two speed settings:
 - Step 1** 12,000 rpm
 - Step 2** 17,000 rpm



GRILL CHILL &

for red-blooded males

Accessories



Multi-purpose blade



Beater blade



Whisk blade



Meat/vegetable blade



Processor



PowderDisc



Mayonnaise tub



Beaker 400 ml



Stand



Cookbook



Apron

The delicious grilling tool

- › Ideal gift for men and BBQ fans
- › Stunning cooking booklet with fantastic BBQ recipes inside
- › Branded apron completes the perfect BBQ outfit
- › Chill & grill



black

Technical data

- › 200 W heavy-duty AC motor
- › Double insulation
- › Twin switch for two speed settings:
- Step 1** 12,000 rpm
- Step 2** 17,000 rpm

toGo fresh and fit through the day

for work

for school

for beauty

for sport



Accessories



Multi-purpose blade



Beater blade



Whisk blade



Meat/vegetable blade



Cookbook



Thermo cup

The fresh and fit maker

- › Covers a huge target group
- › Perfect for school, work, sport and beauty
- › Comes with a thermo cup which keeps warm/hot and cold for many hours
- › Innovative cooking booklet inside with lot of inspirational recipes



laguna

Technical data

- › 200 W heavy-duty AC motor
- › Double insulation
- › Softgrip safety switch
- › 2 speed settings:
 - Step 1** 12,000 rpm
 - Step 2** 17,000 rpm

baking
HAPPINESS IS HOMEMADE

Accessories



Multi-purpose blade



Beater blade



Whisk blade



Meat mincer



Processor



PowderDisc



Beaker 400 ml



Beaker 600 ml



Jug 1000 ml



SliceSy[®]



Stand



Cookbook



The extraordinary appliance

- › The all in one kitchen appliance
- › Power pack and indispensable help in the kitchen
- › Cooking booklet with lots of baking recipes (sweet and salty) inside
- › Perfect gift for baking maniacs



Technical data

- › 200 W heavy-duty AC motor
- › Double insulation
- › Twin switch for two speed settings:
 - Step 1** 12,000 rpm
 - Step 2** 17,000 rpm



Accessories



Multi-purpose blade

The fascinating original

- › Basic model
- › Modern
- › Available in many attractive colours
- › Perfect performance
- › Wide range of colour combinations thanks to coloured seal ring



Technical data

- › 120–200 W heavy-duty AC motor
- › Double insulation
- › Softgrip safety switch
- › 2 speed settings (depending on motor rating):
 - Step 1** 12,000 rpm
 - Step 2** 17,000 rpm



Accessories



Multi-purpose blade



Beater blade



Whisk blade



Beaker 600 ml

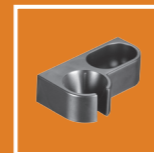

Wall bracket



The cosmopolitan

- › Premium model
- › Unrivalled versatility
- › Available in trendy colours
- › Top-grade materials and beautiful finish



Technical data

- › 140–200 W heavy-duty AC motor
- › Double insulation
- › Twin switch for two speed settings (depending on motor rating):
 - Step 1** 10,000–12,000 rpm
 - Step 2** 15,000–17,000 rpm





Accessories



Multi-purpose blade



Beater blade



Whisk blade



Grinder



Stand



Full of surprises

- › Designed for universal use
- › Multi-function appliance
- › Processes even the hardest ingredients
- › Reliable partner in the kitchen



Technical data

- › 160–200 W heavy-duty AC motor
- › Double insulation
- › Twin switch for two speed settings:
 - Step 1** 10,000–12,000 rpm
 - Step 2** 16,000–17,000 rpm



Accessories



Multi-purpose blade



Beater blade



Whisk blade

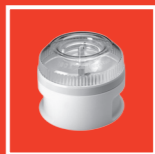

Processor



Jug 1000 ml

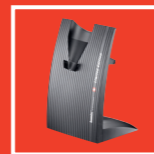

Stand



The universal companion

- › Top-range product
- › Outstanding performance
- › Striking look
- › With handy and stylish stand



Technical data

- › 200W heavy-duty AC motor
- › Double insulation
- › Softgrip safety switch
- › 2 speed settings:
 - Step 1** 12,000 rpm
 - Step 2** 17,000 rpm





Accessories



The power pack

- › The indispensable help in the kitchen
- › All-in-one kitchen appliance
- › Can process virtually any ingredient
- › Powerful and efficient



Technical data

- › 200W heavy-duty AC motor
- › Double insulation
- › Softgrip safety switch
- › 2 speed settings:
 - Step 1** 12,000 rpm
 - Step 2** 17,000 rpm



Reporting for duty

- › The professional appliance for professionals
- › Indispensable and always efficient
- › Top performance guaranteed
- › Extremely durable
- › Available with various shaft lengths for small and large portions



Accessories



Multi-purpose blade



Beater blade



Whisk blade

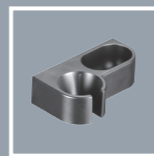

Wall bracket

Technical data

Gastro 180 W

- › 180 W, two-speed motor
- › Softgrip switch
- › Coiled cord
- › Overall length: 34.0 cm
- › Immersion depth: 20 cm
- › 2 speed settings:

Step 1 11,500 rpm
Step 2 16,500 rpm

Gastro 200 W

- › 200 W, two-speed motor
- › Softgrip switch
- › Coiled cord
- › Overall length: 39.5 cm
- › Immersion depth: 25 cm
- › 2 speed settings:

Step 1 12,000 rpm
Step 2 17,000 rpm

Gastro 350 W

- › 350 W, two-speed motor
- › Softgrip switch
- › Coiled cord
- › Overall length: 49.5 cm
- › Immersion depth: 35 cm
- › 2 speed settings:

Step 1 18,000 rpm
Step 2 22,000 rpm



Accessories

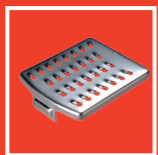

SliceSy® grater fine, no. 1



SliceSy® grater medium, no. 2



SliceSy® grater coarse, no. 3

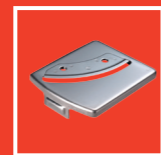

SliceSy® slicer fine, no. 4

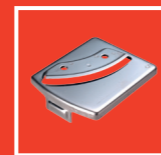

SliceSy® slicer coarse, no. 5



SliceSy® chopping blade

bamix® SliceSy®

- › The perfect bamix® accessory
- › Chopping, grating, slicing, grinding – all done in no time
- › For mixing and stirring dough
- › With special insert to prevent ingredients becoming stuck in the SliceSy®



Technical data

Compatible with all bamix® models from 180 W

With handy insert to remove all processed food in one go from the SliceSy®.





The powerful helper

- › Grinds and chops all your ingredients
- › Ideal for herbs, cereals, spices, coffee and nuts
- › The PowderDisc turns pepper corns or whole nutmegs into fine powders



Accessories



PowderDisc

Technical data

Compatible with all bamix® models except Gastro 350 W – G3



bamix[®] accessories

bamix[®] accessories Puréeing. Whipping. Emulsifying. Chopping.



The **bamix[®] multi-purpose blade** for mashing vegetables and cooked meat in soups, sauces and baby food; for mincing fresh and frozen fruit and berries for desserts, jams, ice cream and sorbets. The multi-purpose blade even crushes ice cubes for refreshing drinks and cocktails.



The **bamix[®] beater blade** produces deliciously frothy whipped cream, whipped egg whites, frappés, soufflés and other desserts; blends sauces and shakes, and even beats low-fat milk to a perfect mousse.



The **bamix[®] whisk blade** is the ideal tool for pancake mixes and egg doughs, salad dressings, mayonnaise, mashed potatoes, cocktails and shakes.



The **bamix[®] meat mincer** cuts, minces and purées both raw and cooked meat as well as fish and long-fibre vegetables.

bamix[®] processor and grinder Grinding. Mincing. Pulverising.



bamix[®] grinder turn your muesli into a treat. Freshly ground ingredients, topped with nuts, fill you with energy. Enjoy your breakfast with a full-flavoured coffee made from freshly ground beans.

For people who love herbs and spices, the **processor** is simply a must: nothing tastes better and more genuinely exotic than freshly ground cinnamon, nutmeg or chili.

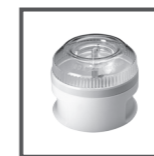

The processor and the transparent **grinder** also chip chocolate for tasty cakes and decorations. They turn sugar cubes into icing sugar and chop dry bread into bread-crumbs – clean and easy.

Use the attachments to chop any dry foodstuff such as cured meat, dried vegetables and mushrooms, hard cheese, nuts, cereals and seeds. Or turn peanuts into peanut butter.

The processor and grinder are equally indispensable for moist food. Mince and blend small portions of bread spreads and baby food, chop garlic, onions, coconut flesh, chili peppers, horse radish and kitchen herbs, or small portions of meat or fish, and boiled

bamix[®] containers Handy. Versatile.



bamix[®] beakers come with snap-on lids. They are therefore not only perfect for use with the **bamix[®]**, but also serve as storage containers for all types of food. Made from top-quality materials, they are shatter-proof and heat-resistant up to +150 °C. The beakers and jugs made from foodgrade material are dishwasher-proof and can be placed in the freezer and in the microwave oven.

All pictures and descriptions refer to standard models. The technical specifications of the models available in your country might vary slightly. bamix[®] and SliceSy[®] are protected trademarks of ESGE AG.

All-in-one kitchen appliance

bamix® is the smallest yet most efficient and versatile kitchen appliance in the world. Thanks to the various **bamix**® accessories, the appliance is the ideal helper for a huge range of tasks.

It can be used to chop, mince, purée, emulsify, mix, blend, froth, grind, pulverise, grate and whip food. At the same time, the **bamix**® is extremely easy to operate and clean.

With only two accessories, namely the SliceSy® and the processor, your **bamix**® becomes the master of all tasks in your kitchen. Small and compact.



bamix[®]
of Switzerland

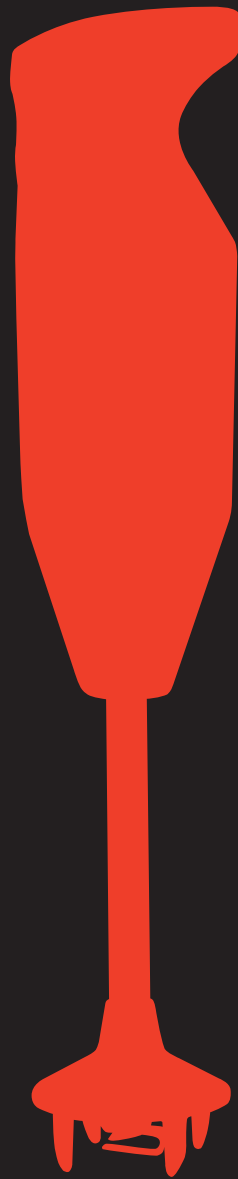

bamix.com

ESGE AG (Ltd.), Hauptstrasse 21, CH 9517 Mettlen/Switzerland